

Jet Towel Hand dryer

MODEL

JT-SB216JSH2-W-NE	Heater Model
JT-SB216JSH2-H-NE	
JT-SB216JSH2-S-NE	
JT-SB216KSN2-W-NE	Heater-less Model



Model Name Display Position
Appliance handling differs depending on the model. Therefore, be sure to check the model name of your appliance.



Appliance color -W(White), -H(Dark grey), -S(Silver)

Single-phase 220-240V AC

INSTRUCTION MANUAL

For User

- Read this manual thoroughly before use to ensure the appliance is used safely and correctly. After reading the manual, store it in an easily accessible location for future reference.

You should not attempt to install the appliance yourself. (The safety and functionality of the appliance cannot be guaranteed.)

This product is intended for the purpose of drying hands and is not covered by the warranty if used for any other purpose. It has no sterilizing or disinfecting functions.

INDEX

Safety Precautions	2
■ Names of Parts	3
How to use the appliance	4
■ Turning the power on	4
■ After washing hands	4
■ If not using for a long period	4
Maintenance	5
1. Cleaning the appliance exterior and hand drying area ..	5
2. Cleaning the air filter	6
3. Draining and cleaning the drain tank	6
4. Cleaning the drain pipe	7
If you think something has gone wrong	8
Specifications	9
■ Drying times for different modes (approximate) and uses	9

(Safety Precautions)



Warning

The following may lead to death or serious personal injury if handled incorrectly

 Prohibited	<ul style="list-style-type: none"> Do not open the front panel Doing so may result in an electric shock. Do not use at locations where salt damage may occur, or where corrosive, neutral, or reductive gases are present. The above may cause fire, electric shocks or malfunctions. 	 Do not disassemble	<ul style="list-style-type: none"> Do not modify or disassemble the appliance. Doing so may cause fires, electric shocks or injury. When changing the installation place, consult your dealer or installer. There is a risk of injury.
 Do not use in the bathroom/ shower room	<ul style="list-style-type: none"> Do not use this appliance near bathtubs, showers, basins or other vessels containing water. 	 Follow instructions	<ul style="list-style-type: none"> Use single-phase 220-240V power. Using the incorrect power supply may cause fires, electric shocks or malfunctions. Use exclusive wiring Using this appliance with other devices on a branch socket may cause abnormal heat, which may cause fires. Always turn off the power during maintenance work. Failure to do so may result in an electric shock.
 Do not allow the appliance to get wet	<ul style="list-style-type: none"> Do not allow water to get on the appliance. This may cause electric shocks or malfunctions. 		



Caution

The following may lead to injury or damage to property if the appliance is handled incorrectly.

 Prohibited	<ul style="list-style-type: none"> This appliance can be used by children aged from 8 years and above and persons with reduced physical, sensory or mental capabilities or lack of experience and knowledge if they have been given supervision or instruction concerning use of the appliance in a safe way and understand the hazards involved. Children shall not play with the appliance. Cleaning and user maintenance shall not be made by children without supervision. Do not use for drying anything other than hands. Inappropriate use may cause an accident. 	 Follow instructions	<ul style="list-style-type: none"> Always use the appliance with the drain tank, air filter, and side covers attached. Any water entering the appliance may cause short circuits, electric shocks or damage. If the appliance stops working or if a malfunction occurs, turn off the power and ground-fault circuit interrupter before contacting your dealer for an inspection and repairs. Failure to do any of the above may result in electric shocks or short circuits, or fires due to short-circuiting.
 Follow instructions	<ul style="list-style-type: none"> Wear rubber gloves when cleaning the appliance. Not doing so may result in injuries. 		

Note

- Do not use in the following locations.

- Outdoors
- Locations where the temperature could be lower than 0°C.
- Locations where there is a lot of dust.
- Locations where the temperature could be higher than 40°C.
- Locations where there is a lot of condensation.
- Locations where salt damage may occur.
- Vehicles (including ships and airplanes)
- Locations where the appliance is in direct or strong sunlight (May cause the sensor to malfunction)
- Near food or tableware.
- Locations where the appliance may come into direct contact with water.
- Kitchens (Where there is a risk of water splashing.)
- Locations where corrosive, neutral, or reductive gases are present.
(This may shorten the working life of the appliance and/or cause malfunctions.)
- Rooms that have a sterilization basin, swimming pools, bathrooms.

- Do not use with chemicals on your hands.
(This may damage the surface of the appliance, or cause discoloration or cracking.)
- Be sure to completely wipe off any detergents or chemicals on the appliance.
(Failure to do so may damage the surface of the appliance, or cause discoloration or cracking.)
- Only use the specified cleaning agents.
(For details on detergents, see the "Maintenance" section.)
- If water is sucked into the appliance, it may cause damage to the mechanism, or moisture may be absorbed into the soundproofing material, allowing bacteria to breed. Therefore, do not allow water to come in contact with the air filter or air duct.

Names of Parts

※ Shaded areas in the figure indicate antibacterial material.

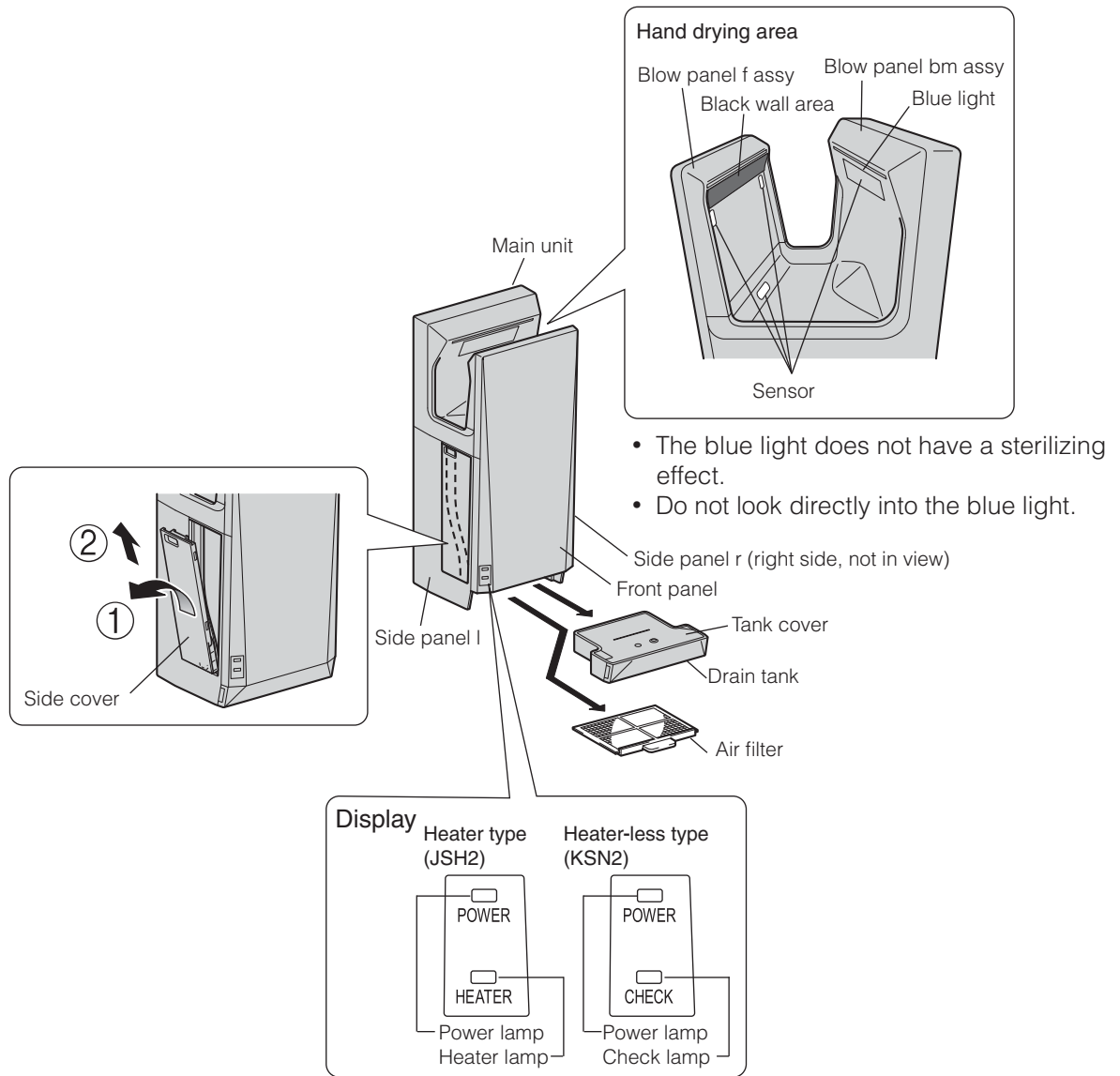

This information is based on REGULATION(EU) No 528/2012

MODEL NAME: JT-SB216JSH2, JT-SB216KSN2

Treated Article (Parts name)	Active substances (CAS No.)	Property	Instruction for Use (Safe handling information)
Blow panel f assy	Silver Phosphate Glass CASNO. 308069-39-8	Antibacterial	<ul style="list-style-type: none"> - Use this product in line with the instruction manual indications and for the intended purpose only. - Do not put into mouth. Keep away from children.
Blow panel bm assy			
Side panel l			
Side panel r			
Drain tank			
Tank cover			
Front panel			

(How to use the appliance)

■ Turn the ground-fault circuit interrupter "ON".

The power light (blue) turns on.

Caution

- **Do not turn the power on when your hands or an object are inside the hand drying area.**
The sensitivity of the sensor may be reduced if the power is turned on while your hands or objects are inside the hand drying area.
If the sensitivity of the sensor is reduced, please turn the power off and then back on after one minute.

■ After washing hands

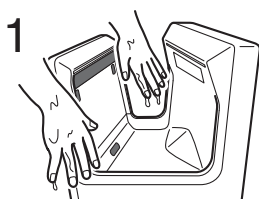

1 Wet hands

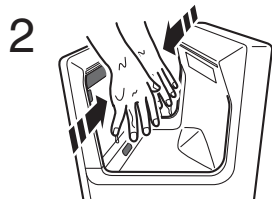

2 Insert hands from the side

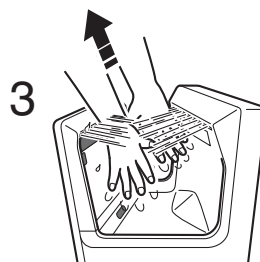

3 Bring hands upwards

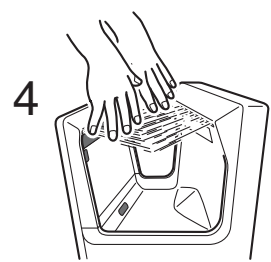

※ Repeat 2-3 times

Automatic Stop Function All models

The power lamp flashes and the dryer stops automatically if the appliance is used continually for more than 30 seconds. To continue using the hand dryer, remove your hands, and then re-insert them.

Simple heater

JT-SB216JSH2 type only (not applicable to JT-SB216KSN2)

Softens the feeling of cold air.

If the room temperature is above 30°C, the heater will stop working to prevent the temperature from rising too high.

NOTE

- If the room temperature is less than 18°C, the air may feel cold.

■ If not using for a long period

Turn the ground-fault circuit interrupter "OFF".

Maintenance



Warning

- Always turn off the power during maintenance work. Failure to do so may result in an electric shock.
- Do not allow water to get on the appliance. This may cause electric shocks or malfunctions.



Caution

- Wear rubber gloves when cleaning the appliance. Not doing so may result in injuries.

Cautions

- Only use cleaning products that are labeled as "Safe to use on plastics".
- Do not use any of the following cleaning materials (They may damage the surface of the appliance, or cause discoloration or cracking.)
 - Solvents such as thinner or benzene
 - Acid, alkaline or chlorine detergents
 - Mold and mildew removers
 - Citrus-based or other plant-based detergents
 - Nylon scourers or abrasives
 - Antiseptics
- Do not clean the front cover of a silver appliance with alcohol. (This may damage the surface of the appliance, or cause discoloration or cracking.)
 - ※ "Alcohol" means a disinfectant with an ethanol content of 83% or less.
 - ※ Be sure to dispose of any alcohol that has collected in the drain tank.
 - ※ Do not spray alcohol directly onto the appliance.

Damage to the appliance (such as rusting) is not covered by the warranty if the above cautions are not observed.

NOTE

- When cleaning the appliance, use a neutral detergent. (pH: 6-8)
- The exterior of the appliance can be wiped with alcohol. (Excluding the front cover of silver models)
- After cleaning with neutral detergent or alcohol, be sure to wipe away all remaining traces of the detergent or alcohol.
- After wiping the appliance clean with alcohol, be sure to dispose of any alcohol that has collected in the drain tank.
 - ※ Do not spray alcohol directly onto the appliance.
- When using a chemical cloth, be sure to follow the instructions carefully.

1 Cleaning the appliance exterior and hand drying area

If it is particularly dirty

- 1 Turn the ground-fault circuit interrupter "OFF".
- 2 Wipe with a well-wrung wet cloth

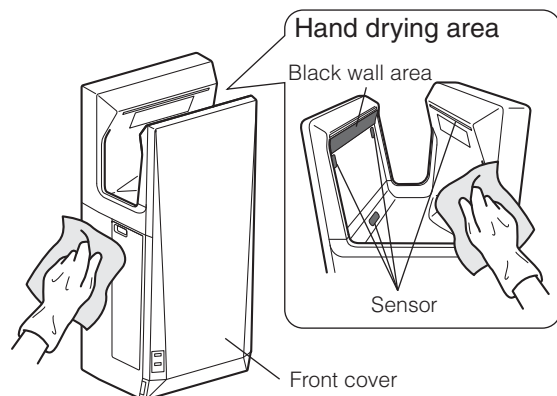

NOTE

- After cleaning with neutral detergent or alcohol, be sure to wipe away all remaining traces of the detergent or alcohol.
- Clean the sensor area about once a week.

2

Cleaning the air filter

Around once a week

1 Turn the ground-fault circuit interrupter "OFF".

2 Remove the drain tank and air filter

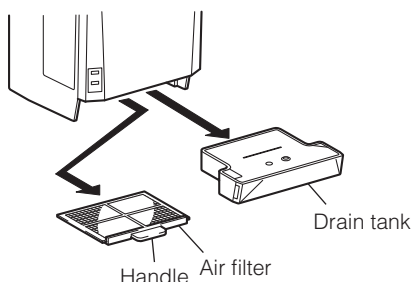

3 Tap gently by hand

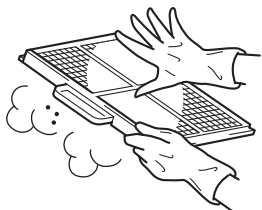

or

2 Use a vacuum cleaner to remove dust

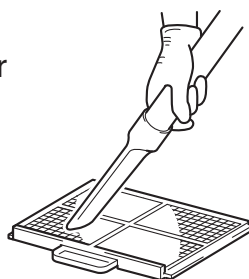

3 Reinstall the drain tank and air filter

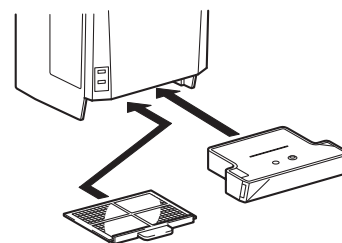

NOTE

- If the air filter is particularly dirty, clean it with warm or cold water.
- After washing the air filter with water, dry it thoroughly.

Cautions

- Never dry the air filter using a heat source such as flames or a dryer. This may damage the filter or cause fires.
- Ensure that the air filter is fitted properly. Dirt and dust may get into the appliance and shorten its working life if the air filter is out of position.

3

Draining and cleaning the drain tank

Before it fills up (at least once a week)

1 Turn the ground-fault circuit interrupter "OFF".

2 Remove the drain tank

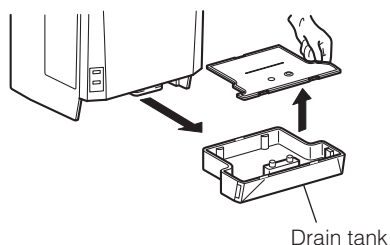

3 Empty the water, and wash the lid and drain tank.

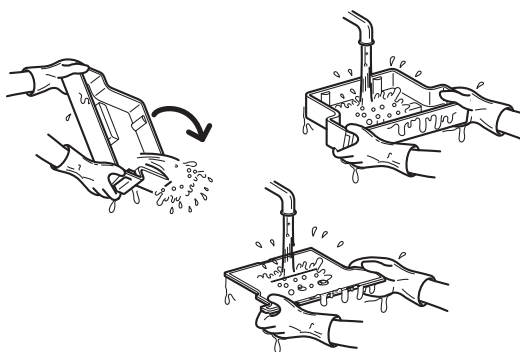

4 Attach the lid

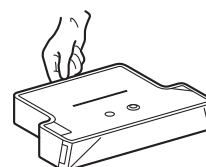

5 Reinstall the drain tank

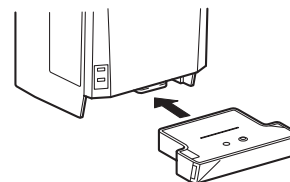

NOTE

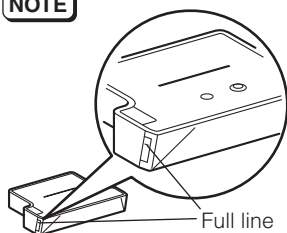

- Empty the drain water at least once a week before the drain water exceeds the full line.

Cautions

- Empty the drain tank regularly. If the drain tank is not emptied it will start to smell, and the drain water may leak onto the floor causing the floor to become dirty.
- Ensure that the drain tank is fitted properly.

4

Cleaning the drain pipe

At least once a week

1 Turn the ground-fault circuit interrupter "OFF".

2 Hook your fingers into the handle on the side cover, and pull it diagonally upwards

3 Wipe the inside of the side cover and drain pipe with a well-wrung wet cloth

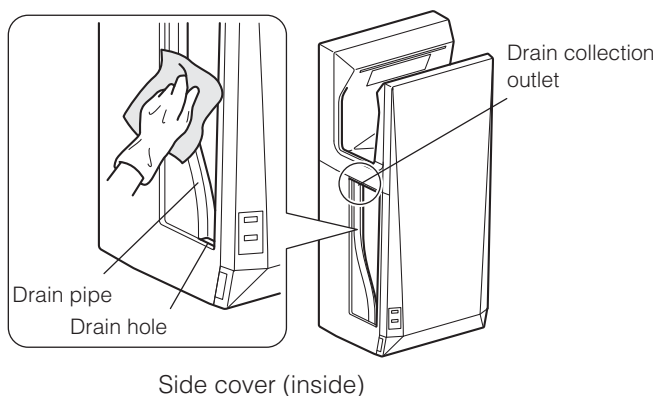
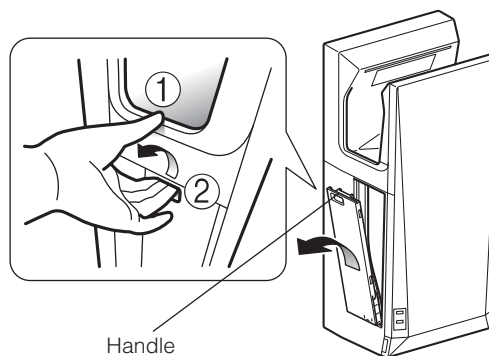

NOTE

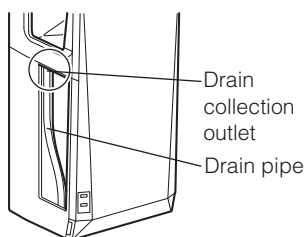

- Gently wipe any dirt from the drain using a soft cloth.
- Do not pour water directly onto the drain pipe.

4 After cleaning, attach the side cover.

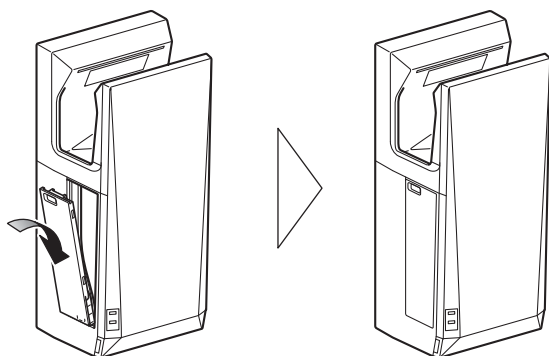

Cautions

- Ensure that the side cover is fitted properly.

—(If you think something has gone wrong)—

Perform the following checks and fixes.

Problem	Check	Fix
No air blows even if hands are inserted	Are any lamps in the display on? Has a blackout occurred?	• Turn the ground-fault circuit interrupter on.
	Are you putting your hands in all the way?	• Place your hands all the way inside the hand drying area.
Air does not stop	Was the ground-fault circuit interrupter turned on while your hands or an object was inside the hand drying area?	• Turn the ground-fault circuit interrupter "OFF", and when the display lamps all go out, remove any foreign substances or dirt. Wait for at least 1 minute after turning the ground-fault circuit interrupter "OFF", and then turn it back "ON" again.
	Is the sensor blocked by dirt or dust?	
Stops operating during hand drying	Is the black wall area in the hand drying area white with dirt?	
	Has the dryer been used continually for more than 30 seconds? Are any lamps in the display flashing?	• If the hand dryer is used continually for more than 30 seconds, the power lamp flashes, and the dryer automatically stops. To continue using the hand dryer, remove your hands, and then re-insert them.
Air is cold Air does not warm up	The heater lamp is off. (Only for JT-SB216JSH2 type)	• Contact the dealer about any changes to the settings. Costs are as agreed with the dealer.
	Air conditioning is not working.	• The air may not feel warm if the room temperature is less than 18°C. (The JT-SB216KSN2 type is not equipped with a simple heater)
	Check the model name of the product.	• The JT-SB216KSN2 model is not equipped with an internal heater, and therefore hot air does not blow.
	Is the room temperature too high?	• If the room temperature is above 30°C, the heater will stop working to prevent the temperature from rising too high.
The lamp does not light up even when the ground-fault circuit interrupter on.	Has a blackout occurred? The ground fault circuit interrupter is "OFF".	• Turn the ground-fault circuit interrupter on.
The display section lamp flashes	This may flash if there is a malfunction in the power supply.	• Turn the ground-fault circuit interrupter "OFF", check that all of the lamps on the display section are off, and then wait for 1 minute before switching ground-fault circuit interrupter back "ON".
Crack-like shapes can be seen around the nozzle	There is no unevenness, even when touched by hand. (No feeling of cracking)	• This pattern occurs when the product is molded (manufactured). It does not affect product performance, and is not a malfunction.
The operating sound is too loud (Air blow is too strong) I want to reduce power consumption (want to turn off the heater) (Only for JT-SB216JSH2 model)	• Contact your dealer for any changes to settings or adjustments etc. Costs are as agreed with the dealer.	<p>Cautions</p> <ul style="list-style-type: none"> • Do not attempt to modify or disassemble this appliance yourself.
If the above fixes do not work, turn off the ground-fault circuit interrupter, and have your dealer inspect and if necessary repair the appliance. (Costs are as agreed with the dealer.)		

(Specifications)

Model	Voltage	Frequency	Power Input (W)	Current (A)	Weight (kg)	Dimensions (WxDxH)
JT-SB216JSH2 [*]	220-240V	50-60Hz	1240	5.7 - 6.2	11	300 × 219 × 670 (mm)
JT-SB216KSN2			720	3.9 - 4.2		

- The values above are when the air volume is "high".
- The drain tank capacity is 0.8ℓ.
- ^{*}With simple heater.

■ Drying times for different modes (approximate) and uses

Mode	Drying times (approximate) [*]		Noise	Use
	JT-SB216JSH2	JT-SB216KSN2		
HIGH	9~11secs	11~13secs	approx. 59dB	To dry hands quickly
STANDARD	11~13secs	13~15secs	approx. 56dB	To achieve both quick drying and low noise

^{*}Drying times are based on Mitsubishi measurements. (50mg of water per hand)



HEAD OFFICE: TOKYO BLDG., 2-7-3, MARUNOUCHI, CHIYODA-KU, TOKYO 100-8310, JAPAN
 AUTHORIZED REPRESENTATIVE IN EU:
 MITSUBISHI ELECTRIC EUROPE B.V.
 HARMAN HOUSE, 1 GEORGE STREET, UXBRIDGE, MIDDLESEX UB8 1QQ, U.K.

Information on Disposal



Note: This symbol mark is for EU countries only.

This symbol mark is according to the directive 2012/19/EU Article 14 Information for users and Annex IX, and/or to the directive 2006/66/EC Article 20 Information for end-users and Annex II.

English

Your MITSUBISHI ELECTRIC product is designed and manufactured with high quality materials and components which can be recycled and/or reused.

This symbol means that electrical and electronic equipment, batteries and accumulators, at their end-of-life, should be disposed of separately from your household waste.

If a chemical symbol is printed beneath the symbol shown above, this chemical symbol means that the battery or accumulator contains a heavy metal at a certain concentration. This will be indicated as follows:

Hg: mercury (0,0005%), Cd: cadmium (0,002%),

Pb: lead (0,004%)

In the European Union there are separate collection systems for used electrical and electronic products, batteries and accumulators.

Please, dispose of this equipment, batteries and accumulators correctly at your local community waste collection/recycling centre.

Please, help us to conserve the environment we live in!

Deutsch

Ihr MITSUBISHI ELECTRIC-Produkt wurde unter Einsatz von qualitativ hochwertigen Materialien und Komponenten konstruiert und gefertigt, die für Recycling und/oder Wiederverwendung geeignet sind.

Dieses Symbol bedeutet, dass elektrische und elektronische Geräte sowie Batterien und Akkus am Ende ihrer Nutzungsdauer von Hausmüll getrennt zu entsorgen sind.

Wenn ein chemisches Symbol unterhalb des oben abgebildeten Symbols erscheint, bedeutet dies, dass die Batterie bzw. der Akku ein Schwermetall in einer bestimmten Konzentration enthält. Dies wird wie folgt angegeben:

Hg: Quecksilber (0,0005 %), Cd: Cadmium (0,002 %),

Pb: Blei (0,004 %)

In der Europäischen Union gibt es unterschiedliche Sammelsysteme für gebrauchte Elektrik- und Elektronikgeräte einerseits sowie Batterien und Akkus andererseits.

Bitte entsorgen Sie dieses Gerät, Batterien und Akkus vorschriftsmäßig bei Ihrer kommunalen Sammelstelle oder im örtlichen Recycling-Zentrum.

Bitte helfen Sie uns, die Umwelt zu erhalten, in der wir leben!

Italiano

Questo prodotto MITSUBISHI ELECTRIC è stato progettato e fabbricato con materiali e componenti di alta qualità, che possono essere riciclati e/o riutilizzati.

Questo simbolo significa che i prodotti elettrici ed elettronici, le batterie e gli accumulatori, devono essere smaltiti separatamente dai rifiuti casalinghi alla fine della loro vita di servizio.

Se sotto il simbolo mostrato sopra è stampato un simbolo chimico, il simbolo chimico significa che la batteria o l'accumulatore contiene un metallo pesante con una certa concentrazione. Ciò viene indicato come segue:

Hg: mercurio (0,0005%), Cd: cadmio (0,002%),

Pb: piombo (0,004%)

Nell'Unione Europea ci sono sistemi di raccolta differenziata per i prodotti elettrici ed elettronici, le batterie e gli accumulatori usati.

Per disfarsi di questo prodotto, delle batterie e degli accumulatori, portarli al centro locale di raccolta/riciclaggio dei rifiuti.

Aiutateci a conservare l'ambiente in cui viviamo!

Français

Votre produit Mitsubishi Electric est conçu et fabriqué avec des matériels et des composants de qualité supérieure qui peuvent être recyclés et/ou réutilisés.

Ce symbole signifie que les équipements électriques et électroniques, les batteries et les accumulateurs, à la fin de leur durée de service, doivent être éliminés séparément des ordures ménagères.

Si un symbole chimique est imprimé sous le symbole illustré ci-dessus, il signifie que la batterie ou l'accumulateur contient une certaine concentration de métal lourd. Elle sera indiquée comme suit :

Hg : mercure (0,0005%), Cd : cadmium (0,002%),

Pb : plomb (0,004%)

Dans l'Union Européenne, il existe des systèmes sélectifs de collecte pour les produits électriques et électroniques, les batteries et les accumulateurs usagés.

Nous vous prions donc de confier cet équipement, ces batteries et ces accumulateurs à votre centre local de collecte/recyclage.

Aidez-nous à conserver l'environnement dans lequel nous vivons !

Les machines ou appareils électriques et électroniques contiennent souvent des matières qui, si elles sont traitées ou éliminées de manière inappropriée, peuvent s'avérer potentiellement dangereuses pour la santé humaine et pour l'environnement.

Cependant, ces matières sont nécessaires au bon fonctionnement de votre appareil ou de votre machine.

Pour cette raison, il vous est demandé de ne pas vous débarrasser de votre appareil ou machine usagé avec vos ordures ménagères.

Español

Su producto MITSUBISHI ELECTRIC está diseñado y fabricado con materiales y componentes de alta calidad que pueden ser reciclados y/o reutilizados.

Este símbolo significa que el aparato eléctrico y electrónico, las pilas, baterías y los acumuladores, al final de su ciclo de vida, se deben tirar separadamente del resto de sus residuos domésticos.

Si hay un símbolo químico impreso debajo del símbolo mostrado arriba, este símbolo químico significa que la pila, batería o el acumulador contienen un metal pesado con cierta concentración. Esto se indicará de la forma siguiente:

Hg: mercurio (0,0005%), Cd: cadmio (0,002%),

Pb: plomo (0,004%)

En la Unión Europea existen sistemas de recogida específicos para productos eléctricos y electrónicos, pilas, baterías y acumuladores usados.

Por favor, deposite los aparatos mencionados, las pilas, baterías y acumuladores en el centro de recogida/reciclado de residuos de su lugar de residencia local cuando quiera tirarlos.

¡Ayúdenos a conservar el medio ambiente!

Português

O seu produto MITSUBISHI ELECTRIC foi concebido e produzido com materiais e componentes de alta qualidade que podem ser reciclados e/ou reutilizados.

Este símbolo significa que o equipamento eléctrico e electrónico, as baterias e os acumuladores, no final da sua vida útil, devem ser deitados fora separadamente do lixo doméstico.

Se houver um símbolo químico impresso por baixo do símbolo mostrado acima, o símbolo químico indica que a bateria ou acumulador contém metais pesados numa determinada concentração. Isto aparecerá indicado da maneira seguinte:

Hg: mercúrio (0,0005%), Cd: cádmio (0,002%),

Pb: chumbo (0,004%)

Na União Europeia existem sistemas de recolha separados para produtos eléctricos e electrónicos, baterias e acumuladores usados.

Por favor, entregue este equipamento, as baterias e os acumuladores correctamente, no seu ponto local de recolha/reciclagem.

Por favor, ajude-nos a conservar o ambiente em que vivemos!



Svenska

Denna produkt från MITSUBISHI ELECTRIC är designad och tillverkad av material och komponenter med hög kvalitet som kan återvinnas och/eller återanvändas.

Denna symbol betyder att förbrukade elektriska och elektroniska produkter, batterier och ackumulatörer skall sorteras och hanteras separat från hushållsavfall.

Om det finns en kemisk beteckning tryckt under ovanstående symbol betyder det att batteriet eller ackumulatören innehåller en tungmetall med en viss koncentration. Detta anges på följande sätt:

Hg: kvicksilver (0,0005%), Cd: kadmium (0,002%),
Pb: bly (0,004%)

Inom den Europeiska Unionen finns det separata insamlingsystem för begagnade elektriska och elektroniska produkter, batterier och ackumulatörer.

Var vänlig lämna denna produkt, batterier och ackumulatörer hos din lokala mottagningsstation för avfall och återvinning.

Var snäll och hjälp oss att bevara miljön vi lever i!

Dansk

Dit produkt fra MITSUBISHI ELECTRIC er designet og fremstillet med kvalitetsmaterialer og komponenter, der kan genindvindes og/eller genbruges.

Dette symbol viser, at elektrisk eller elektronisk udstyr, batterier og akkumulatører ikke må bortskaffes sammen med almindeligt husholdningsaffald efter endt levetid.

Hvis der er trykt et kemisk symbol under symbolet ovenfor, betyder det, at batteriet eller akkumulatøren indeholder en bestemt koncentration af et tungmetall. Dette angives som følger:

Hg: kviksølv (0,0005 %), Cd: cadmium (0,002 %),
Pb: bly (0,004 %)

I EU er der særlige indsamlingsordninger for brugte elektriske og elektroniske produkter, batterier og akkumulatører.

Bortskaf udstyret, batterier og akkumulatører korrekt på en lokal affalds-/genbrugsplads.

Hjælp os med at bevare det miljø, vi lever i!

Norsk

For norske brukere:

Dette produktet fra MITSUBISHI ELECTRIC er konstruert og produsert med materialer og komponenter av høy kvalitet, som kan resirkuleres og/eller brukes om igjen.

Dette symbolet betyr at elektrisk og elektronisk utstyr, batterier og akkumulatører, ikke bør kasseres sammen med husholdningsavfallet når de har nådd slutten av sin levetid.

Hvis det er trykt et kjemisk symbol under det symbolet som er vist over, betyr det kjemiske symbolet at batteriet eller akkumulatøren inneholder et tungmetall i en viss konsentrasjon. Dette vil vises som følger:

Hg: kvikksølv (0,0005 %), Cd: kadmium (0,002 %),
Pb: bly (0,004 %)

I Norge finnes det egne innsamlingsystemer for brukte elektriske og elektroniske produkter, batterier og akkumulatører. Kasser dette utstyret, batteriene og akkumulatorene ved den lokale gjenbruks- eller resirkuleringsstasjonen.

Hjelp oss å bevare det miljøet vi lever i!

Suomi

Tämä MITSUBISHI ELECTRIC -tuote on suunniteltu ja valmistettu korkealuokkaisista materiaaleista ja/tai osista, jotka voidaan kierrättää ja käyttää uudelleen.

Tämä symboli tarkoittaa, että sähkö- ja elektroniikkalaitteet, paristot ja akut täytyy niiden käyttöänsä jälkeen hävittää erillään talousjätteistä.

Jos yllä olevan symbolin alapuolelle on painettu kemiallinen symboli, se tarkoittaa, että paristolla tai akulla on tietty raskasmetallipitoisuus. Se ilmoitetaan seuraavasti:

Hg: elohopea (0,0005 %), Cd: kadmium (0,002 %),
Pb: lyijy (0,004 %)

Käytetyillä sähkö- ja elektroniikkalaitteilla, paristoilla ja akuilla on Euroopan Yhteisössä omat keräysjärjestelmänsä.

Toimita tämä laite, paristot ja akut paikalliseen jätehuolto-/kierrätyskeskukseen.

Auta meitä suojelemaan ympäristöä, jossa elämme!

Nederlands

Mitsubishi Electric producten zijn ontwikkeld en gefabriceerd uit eerste kwaliteit materialen. De onderdelen kunnen worden gerecycled en/of worden hergebruikt.

Het symbool betekent dat de elektrische en elektronische onderdelen, batterijen en accu's op het einde van de gebruiksduur gescheiden van het huishoudelijk afval moeten worden ingezameld. Wanneer er onder het bovenstaande symbool een chemisch symbool staat gedrukt, betekent dit dat de batterij of accu zware metalen in een bepaalde concentratie bevat. Dit wordt als volgt aangeduid:

Hg: kwik (0,0005%), Cd: cadmium (0,002%),
Pb: lood (0,004%)

In de Europese Unie worden elektrische en elektronische producten, batterijen en accu's afzonderlijk ingezameld.

Breng deze apparatuur, batterijen en accu's dan naar het gemeentelijke afvalinzamelingspunt.

Help ons mee het milieu te beschermen!

Ελληνικά

Το προϊόν MITSUBISHI ELECTRIC που διαθέτετε είναι σχεδιασμένο και κατασκευασμένο από υλικά και εξαρτήματα υψηλής ποιότητας, τα οποία μπορούν να ανακυκλωθούν ή/και να χρησιμοποιηθούν ξανά.

Το σύμβολο αυτό σημαίνει ότι ο ηλεκτρικός και ηλεκτρονικός εξοπλισμός, οι μπαταρίες και οι συσσωρευτές, στο τέλος της διάρκειας ζωής τους, θα πρέπει να απορριφτούν ξεχωριστά από τα υπόλοιπα οικιακά απορρίμμάτα σας.

Αν έχει εκτυπωθεί ένα χημικό σύμβολο κάτω από το σύμβολο που απεικονίζεται ανωτέρω, αυτό το χημικό σύμβολο σημαίνει ότι η μπαταρία ή ο συσσωρευτής περιέχει ένα βαρύ μέταλλο σε ορισμένη συγκέντρωση. Αυτό θα υποδεικνύεται ως ακολούθως:

Hg: υδράργυρος (0,0005%), Cd: κάδμιο (0,002%),
Pb: μόλυβδος (0,004%)

Στην Ευρωπαϊκή Ένωση υπάρχουν ξεχωριστά συστήματα συλλογής για τα χρησιμοποιημένα ηλεκτρικά και ηλεκτρονικά προϊόντα, τις μπαταρίες και τους συσσωρευτές.

Παρακαλούμε διαθέστε αυτόν τον εξοπλισμό, τις μπαταρίες και τους συσσωρευτές στο τοπικό σας κοινοτικό κέντρο συλλογής/ανακύκλωσης απορριμμάτων.

Βοηθήστε μας να προστατεύσουμε το περιβάλλον στο οποίο ζούμε!

Technical Document of Fan Efficiency

Model Name	JT-SB216JSH, JT-SB216KSN, JT-SB216JSH2, JT-SB216KSN2
Overall Efficiency	52.7%
Measurement Category	C
Efficiency Category	Static
Efficiency Grade	61
VSD	A variable speed drive is integrated within the fan
Year of Manufacture	2012
Manufacturer	Mitsubishi Electric Corporation Head Office: Tokyo Bldg., 2-7-3, Marunouchi, Chiyoda-ku, Tokyo 100-8310, Japan Authorised representative in EU: Mitsubishi Electric Europe B.V.: 1 George Street, Harman House, Uxbridge, Middlesex, UB81QQ Commercial registration no. 33279602
Motor Power Input (kW)	0.66
Flow Rate (m ³ /s)	0.05
Pressure (Pa)	6680
Rotations per Minute	20600
Specific Ratio	1.0
Information relevant for facilitating disassembly, recycling or disposal at end-of-life	Your product should be disposed of separately from household waste in line with local laws and regulations. When this product reaches its end of life, dispose of it at your local waste collection point/recycling centre. The separate collection and recycling of your product at the time of disposal will help conserve natural resources and ensure that it is recycled in a manner that protects human health and the environment. For more information for WEEE recyclers please contact us at http://www.mitsubishielectric.eu/contact_us_form
Information relevant to minimise impact on the environment and ensure optimal life expectancy as regards installation, use and maintenance of the fan	Remove dust on air filter around once a week. Empty the drain water at least once a week before the drain water exceeds the full line.
Description of additional items used when determining the fan energy efficiency	The optimistic fan efficiency is measured in the composition of fan, motor and fan casing only.

Wiring Diagram Diagramme de câblage แผนภาพการเดินสาย 接线图 接線圖 배선도

Current fuse in control circuit
Fusibles à intensité du circuit de commande
ฟิวส์กระแสไฟฟ้าในวงจรควบคุม FUSE1, 2...250 V - 20 A
控制电路内的电流保险丝 FUSE3...250 V - 3.15 A
控制电路內的電流保險絲
제어 회로의 전류 퓨즈

Thermal fuse fusion temperature Température de fusion du fusible thermique อุณหภูมิหลอมละลายของเทอร์มิฟิวส์ 温度保险丝熔断温度 温度保險絲熔斷溫度 온도 퓨즈 오프 온도

THERMAL FUSE1
(Thermal fuse in terminal block)
Fusible thermique du bornier
เทอร์มิฟิวส์ในแผงต่อสายไฟ94°C
接线盘温度保险丝
接線板溫度保險絲
터미널 블록의 온도 퓨즈

THERMAL FUSE2
(Thermal fuse in motor)
Fusible thermique dans le moteur
เทอร์มิฟิวส์ในมอเตอร์133°C
马达内温度保险丝
馬達溫度保險絲
모터의 온도 퓨즈

THERMAL FUSE3
(Thermal fuse in heater)
Fusible thermique du réchauffeur
เทอร์มิฟิวส์ในเครื่องทำความร้อน94°C
加热器内温度保险丝
加熱器溫度保險絲
히터의 온도 퓨즈

- : Lit Allumé 点亮 點亮 켜짐
- ☆ : Blinking (every 0.4 sec) Clignote (toutes les 0,4 sec.) 闪亮 (每0.4秒一次) 閃爍 (每0.4秒一次) 점멸(0.4초마다)
- : Unlit Eteint 熄灭 熄滅 꺼짐
- * : Blinking (every 0.1 sec) Clignote (toutes les 0,1 sec.) 闪亮 (每0.1秒一次) 閃爍 (每0.1秒一次) 점멸(0.1초마다)
- or ● : Lit when the heater switch is on, and unlit when off (JT-SB216JSH ONLY) Lumineux lorsque l'interrupteur du réchauffeur est activé et sombre lorsqu'il est désactivé. 加热器开关ON时点亮, 加热器开关OFF时熄灭。 加熱器開關時點亮, 加熱器關閉時熄滅。 히터가 켜지면 켜지고 히터가 꺼지면 꺼짐

Malfunction location quick reference chart (The display LED light is displayed in the blinking location)

Power LED	Heater LED Check LED	Detected content	Cause
☆ ● ○ ○ ☆ ☆ ● ● ●	○ or ● ○ ☆ ☆ ☆ ☆ ● ● ●	Tamper-proof timer Overvoltage, undervoltage detection Motor lock error Motor overspeed error, step-out error Overcurrent detected Motor current detection error Motor signal error Microcomputer error Fuse fusion	Insertion of foreign objects, continuous operation Overvoltage impress, undervoltage impress, control circuit Power circuit, blower Air filter, blower, power circuit Blower (short circuit), power circuit (overcurrent) Power circuit, disconnected motor Power circuit, disconnected motor Control circuit Current fuse, thermal fuse in motor
Power LED	Heater LED Check LED	Défaut détecté	Cause
☆ ● ○ ○ ☆ ☆ ● ● ●	○ or ● ○ ☆ ☆ ☆ ☆ ● ● ●	Minuterie contre triptotage Surtension détectée, sous-tension détectée Erreur de verrouillage moteur Survitesse du moteur, hors synchronisme Surintensité détectée Erreur de détection de courant du moteur Erreur de signal du moteur Erreur du microprocesseur Fusible grillé	Insertion de corps étrangers, fonctionnement continu Surtension, sous-tension, circuit de commande Circuit d'alimentation, ventilateur Filtre à air, ventilateur, circuit d'alimentation Ventilateur (court-circuit), circuit d'alimentation (surintensité) Circuit d'alimentation, moteur déconnecté Circuit d'alimentation, moteur déconnecté Circuit de commande Fusible à intensité, fusible thermique du moteur
电源 LED	加热 LED Check LED	สิ่งที่พบได้	สาเหตุ
☆ ● ○ ○ ☆ ☆ ● ● ●	○ or ● ○ ☆ ☆ ☆ ☆ ● ● ●	เครื่องจับเวลาที่มีความทนทาน ตรวจสอบแรงดันสูงเกินไป, ตรวจสอบแรงดันต่ำเกินไป ข้อผิดพลาดเกี่ยวกับมอเตอร์ล็อก ข้อผิดพลาดของแรงดันมอเตอร์มีความเร็วสูงเกินไป, ข้อผิดพลาดเกี่ยวกับขั้นตอนการ ตรวจสอบกระแสไฟฟ้าที่มากเกินไป พบข้อผิดพลาดเกี่ยวกับกระแสไฟฟ้าของมอเตอร์ ข้อผิดพลาดเกี่ยวกับสัญญาณมอเตอร์ ข้อผิดพลาดของตัวควบคุมขนาดเล็ก ฟิวส์ละลาย	พบวัตถุแปลกปลอม, ทำงานต่อเนื่อง ตรวจสอบแรงดันไฟฟ้าเกิน, ตรวจสอบแรงดันไฟฟ้าตก, วงจรควบคุม วงจรไฟฟ้า, ไบลาเวอร์ ตัวกรองอากาศ, ไบลาเวอร์, วงจรไฟฟ้า ไบลาเวอร์ (ไฟฟ้าลัดวงจร), วงจรไฟฟ้า (กระแสไฟฟ้าเกิน) วงจรไฟฟ้า, มอเตอร์ตัดการทำงาน วงจรไฟฟ้า, มอเตอร์ตัดการทำงาน วงจรควบคุม ฟิวส์กระแสไฟฟ้า, ฟิวส์ความร้อนในมอเตอร์
电源 LED	加热 LED	检测内容	原因
☆ ● ○ ○ ☆ ☆ ● ● ●	○ or ● ○ ☆ ☆ ☆ ☆ ● ● ●	防恶劣剧定时器 检测到过电压, 电压不足 马达锁定异常 马达超速异常, 失调异常 检测到过电流 马达电流检测异常 马达信号异常 微电脑异常 保险丝熔断	异物插入, 连续运转 电压过大, 电压不足, 控制电路 电源电路, 送风机 空气滤网, 送风机, 电源电路 送风机(短路), 电源电路(过电流) 电源电路, 马达脱开 电源电路, 马达脱开 控制电路 电流保险丝, 马达内温度保险丝
Power LED	Heater LED	检测内容	原因
☆ ● ○ ○ ☆ ☆ ● ● ●	○ or ● ○ ☆ ☆ ☆ ☆ ● ● ●	防破壞定時器 過電壓、欠電壓檢測 馬達鎖定異常 馬達超速異常, 失調異常 檢測到過電流 馬達電流檢測異常 馬達信號異常 微電腦異常 保險絲熔斷	異物插入, 連續運轉 電壓過大, 電壓不足, 控制電路 電源電路, 送風機 空氣過濾網, 送風機, 電源電路 送風機(短路), 電源電路(過電流) 電源電路, 馬達未接通 電源電路, 馬達未接通 控制電路 電流保險絲, 馬達溫度保險絲
전원 LED	히터 LED	감지된 사항	원인
☆ ● ○ ○ ☆ ☆ ● ● ●	○ or ● ○ ☆ ☆ ☆ ☆ ● ● ●	조작 금지 타이머 초과전압, 부족전압 감지 모터 잠금 오류 모터 과속 오류, 동기 이탈 오류 과전류 감지 모터 전류 감지 오류 모터 신호 오류 마이크로컴퓨터 오류 퓨즈 오프	이물질 삽입, 연속 작동 초과전압 유입, 부족전압 유입, 제어 회로 전력 회로, 송풍기 공기 필터, 송풍기, 전력 회로 송풍기(단락), 전력 회로(초과전류) 전력 회로, 단절된 모터 전력 회로, 단절된 모터 제어 회로 전류 퓨즈, 모터의 온도 퓨즈