

# Zip HydroTap® G4

Filtered boiling and chilled drinking water for commercial kitchens and tea rooms.

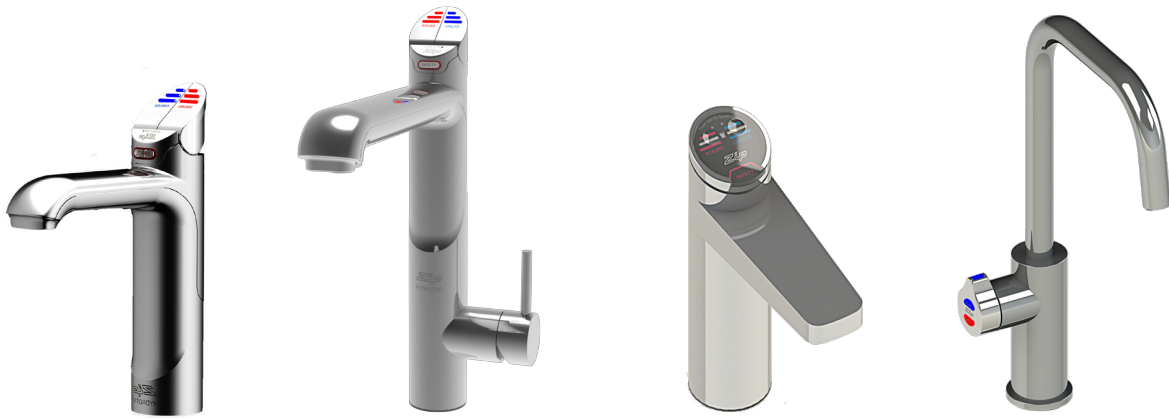

Affix model number label  
here  
801314UK



## Tap options

The G4 series offers a range of interchangeable taps to suit the customer's needs



Classic HydroTap®G4 range



Arc / Cube range

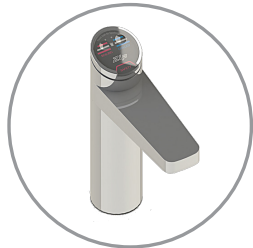

Elite range



Mixer range



All-in-One range

These standalone taps are directly compatible with the G4 Command-Centre™.

The mixer tap range may be used in conjunction with any of the above to provide mixed hot and cold water for sanitary use.

The All-in-One tap may be used as alternatives to any of the above combinations.

# Index

## HydroTap®G4 specifications

Installation check list .....	4
General product features .....	5
Important safety instructions .....	6
Warnings and regulatory information .....	7
Major components and accessories.....	8
Technical specifications .....	9
Before installation and site requirements .....	10

## Installation instructions

**Step 1** - Measure and cut all the tap holes, fit the taps : Refer to 803341UK Tap installation instructions supplied with the tap head.

**Step 2** - Check for adequate ventilation.

Section 1- Ventilation.

1.1- Ventilation for all models .....	11-12
---------------------------------------	-------

**Step 3** - Install the booster and / or filter / softener (if required).

Section 2- Booster installation.

2.1- Booster specifications and descriptions .....	13
2.2- Installation procedure.....	14
2.3- Booster installation.....	14
2.4- Braided hose connections.....	15

Section 3- Filter / softener installation.

3.1- Filter / softener installation .....	16
---	----

**Step 4** - Install the Command-Centre™.

Section 4 - Command-Centre™ installation.

4.1- Check the external bypass valve setting .....	17
4.2- Fit the mains water supply hose .....	17
4.3- HydroTap®G4 models .....	18
4.4- HydroTap®G4 and mixer tap combinations.....	19
4.5- All-in-One 'Mains' tap .....	20
4.6- All-in-One 'Vented' tap .....	21

**Step 5** - Commission the HydroTap®G4.

Section 5 - Commissioning.

5.1- Select language .....	22
5.2- Filter flush .....	22
5.3- Flow calibration .....	22
5.4- Boiling calibration .....	23
5.5- Booster activation .....	23
5.6- Safety sensor calibration.....	23

## Trouble shooting

Trouble shooting table.....	24
End of life disposal .....	25
Warranty.....	25
Contact details .....	28

## Installation checklist

### Before installation

- Read the instructions and check if there is adequate space to install all of the components.
- **Note** Not all fittings are supplied with the appliance kit. Isolation valves are not supplied.
- Check the mains water pressure is within min / max requirements (see page 9).
- Check the water quality to determine if extra filtration will be required.
- **Note** This product must be fitted to a potable water supply.
- Check the Command-Centre™ rating plate and ensure correct power is available.
- Check the under counter cupboard floor supporting the Command-Centre™ is adequate for its total weight, when full of water.

### Before commissioning

- Check the system has been installed correctly.
- Check all plumbing fittings have been tightened.
- Ensure the outlet and vent pipes are positioned to drain correctly.
- Ensure there is adequate ventilation.
- Check all tubes and pipes from the Command-Centre™ to the tap have a constant rise and there are no sags or kinks in the hoses.
- Check all electrical connections are correct and there are no loose wires.

### Commission (see section 5)

- Flush the supply line before connecting.
- Turn on the water and check for leaks.
- Flush the filter(s).
- Activate / enable the booster (if fitted).
- Calibrate the safety sensor for boiling models.
- Where applicable, programme the Command-Centre™ to suit the customer's requirements.

## General product features

Thank you for purchasing a Zip HydroTap®G4. Please read and follow these instructions carefully to ensure safe and trouble free operation. If help and advice is required, please call 0345 6 005 005.

### What is the Zip HydroTap®G4 ?

This Zip HydroTap®G4 is an electronically controlled, filtered, boiling and chilled water drinking system for the kitchen. The HydroTap®G4 systems are under counter drinking water appliances with a dispensing tap mounted on a sink or worktop, which has been designed for commercial applications. The HydroTap®G4 utilises a conventional refrigerant compressor to chill the water and an immersion heating element to boil the water. The boiling and chilled models will dispense boiling water (factory set to 98°C) chilled water (factory set to 5-9°C). These units are NOT designed to be used as sanitary fixtures.

The Zip HydroTap®G4 models which dispense boiling water are fitted with a tap mounted safety lock. In addition, there are various energy saving options accessible via the main menu. The system is equipped with a self-calibrating program which caters for altitude adjustment. The water filter is a disposable item which will require periodic replacement and is covered by a limited OEM warranty.

It is important that the installation be undertaken safely, correctly and completely in order to utilise all the benefits that the HydroTap®G4 can provide. HydroTap®G4 Classic taps can be ordered with the tap head assembly for disabled use. The disabled levers are supplied with Braille caps for the visually impaired.



**Command-Centre™**

## Important safety instructions

This manual contains important safety and installation instructions for the Zip HydroTap®G4. Please read all warnings, installation requirements and installation instructions before installing any Zip HydroTap®G4. This system must be installed in accordance with water supply byelaws, current IEE regulations and relevant local authority byelaws.



### Safety

This appliance is not intended for use by children under 8 years or persons (including children under 8 years) with reduced physical, sensory or mental capabilities, or lack of experience and knowledge, unless they have been given supervision or instruction concerning the use of the appliance by a person responsible for their safety. Children should be supervised to ensure that they do not play with the appliance. Cleaning and user maintenance shall not be made by children without supervision.

### Refrigerant

The Zip HydroTap®G4 Command-Centre™ contains R134A refrigerant under pressure. Maintenance of the refrigeration unit must be carried out by an accredited service provider or qualified refrigeration technician.

### Qualifications

If the power cable is damaged it must be repaired only by a qualified technician. To avoid hazards, all installation procedures must be carried out by a suitably qualified tradesperson. The power cable and power outlet must be in a safe visible position for connection.

### Venting

Sometimes steam and / or boiling water droplets may discharge through a vent outlet on the tap. If the tap is not installed using the font, ensure the tap body is located so the tap outlet safely dispenses into the sink bowl area.

### Lifting

Take care when lifting. The Command-Centre™ may exceed safe lifting limits. If you feel this is beyond your personal capabilities, please seek assistance with the lift. The weights of the Command-Centre™ is marked on the packaging. Do not lift the Command-Centre™ by the front cover or any of its connections. Refer to the technical specification, see page 9, for the weight of the product.

### Airflow

The Zip HydroTap®G4 operates within the ambient temperature range 5°C - 35°C. Proper air circulation must be provided. The system will operate satisfactorily only if the recommended air gaps are provided. See Section 1 'Ventilation', page 11, for correct installation to prevent overheating. The vent kit supplied must be fitted.

### Altitude

Water boils at varying temperatures at different altitudes. The HydroTap®G4 adjusts for this during startup calibration and will recalibrate itself on a regular basis.

### Frost protection

If the HydroTap®G4 is located where the ambient air temperature could fall below 5°C when the heater is not in use, do not turn off the appliance electrically. This safeguard does not offer the same protection to the connecting pipework and fittings.

### Positioning









It is important to ensure the Command-Centre™ is positioned in an accessible area close to the floor level. The Command-Centre™ must have its base mounted in a horizontal position with all inlets and outlets facing up. The tap must be located above the Command-Centre™. See Section 4, Command-Centre™ installation.



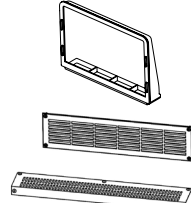







### Warnings

- ⚡ The Zip HydroTap®G4 must be earthed. The resistance of the earth connection from each exposed metal part must be less than 1Ω.
- All installation and service work must be completed by trained and suitably qualified tradespeople. Faulty operation due to unqualified persons working on this product, or any other Zip product may void warranty coverage.
- As the installer, it is your responsibility to supply (if necessary) and install all valves as required by local regulations and relevant standards.
- The HydroTap®G4 is rated for 230V 50Hz AC operation.
- Do not remove the cover of the appliance under any circumstances without first isolating the appliance from the power supply.
- Never locate the Command-Centre™ near, or clean with water jets.
- Do not expose the Zip HydroTap®G4 to the elements of nature.
- Due to the process of continuous improvement, Zip reserves the right to change details mentioned in this manual, without notice.
- Visit [www.zipwater.com/uk](http://www.zipwater.com/uk) to ensure you have the latest copy of this document.

## Major components and accessories

Parts supplied	Description
<b>Tap options</b>	
	1 x HydroTap®G4 Classic Elite or #Arc / Cube #(inc. Tube kit)
	1 x All-in-One HydroTap®G4 Mains or Vented
	1 x Mixer tap Classic, Arc or Cube
<b>Command-Centre™ and components</b>	
	Duct kit 1 x Exhaust duct 1 x Mounting plate 2 x Outlet vent 1 x Inlet vent
	1 x Command-Centre™ with air and water filters
	1 x Mains water connection hose
	1 x Booster inc. connection hoses (supplied with 240 models)
	1 x Installation fittings (supplied with vented mixer tap models)
	1 x User guide and 1 x Quick start guide 1 x Installation instruction

Accessories	Description
	Booster (inc. connection hoses) ZT011
	Scale filter installation kit *ZT200G4 **ZT300G4 Filter not included.
	Font Arc / Cube, 93441UK*** Font Classic / Elite 90915UK***
	Replacement internal 0.2 micron filter ZT402
	Disabled lever kit SP91560 (Classic HydroTap®)
	Mixer upgrade*** SP91546 Classic SP93413 Arc SP93414 Cube
	All-in-One upgrade*** SP93332 (vented) SP93331 (mains)
	Recommended water block HE45004

\*ZT200G4 kit to fit filters

FL2300 (Light commercial use)

FL3600 (Normal commercial use)

\*\*ZT300G4 kit to fit filters

FL6000 Plus (Heavy commercial use)

\*\*\* Chrome finish part numbers are shown,  
alternative finishes are available.



## Technical specifications

### Commercial Boiling Chilled HydroTap®G4 range

#### HydroTap®s

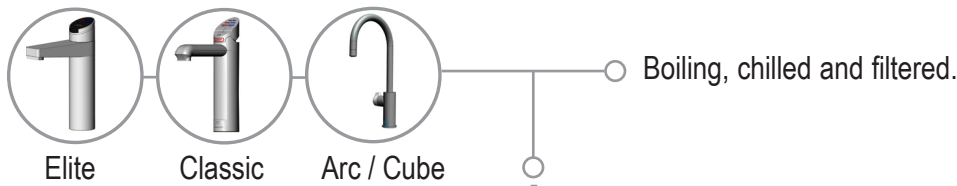

#### Mixer taps

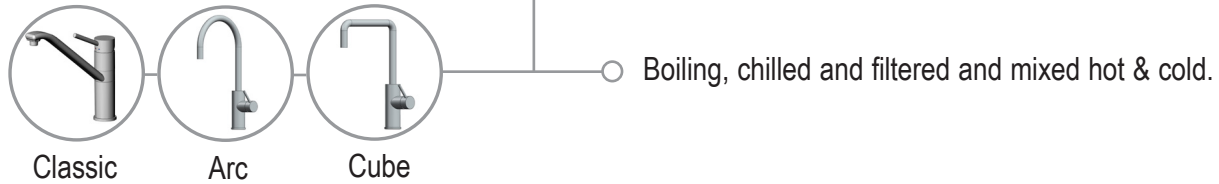

#### All-in-One taps

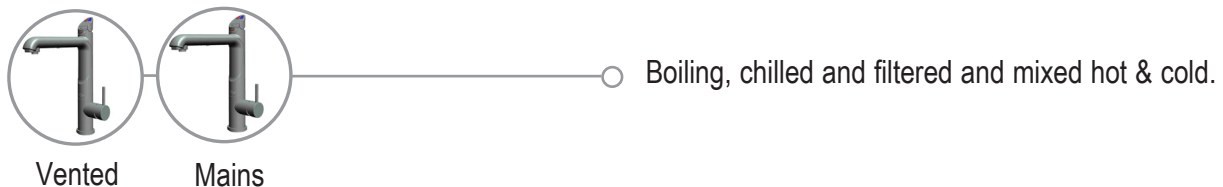

### Specifications

Capacity Boiling (cups 167ml/hr)	Capacity Chilled (glasses 200ml/hr)	Boost (10A)	13A sockets required	Power Rating (kW) 230V	Boost Rating (kW) 230V	Unit Dimensions W x D x H (mm) with air duct	**Dry Weight (kg)
<b>Boiling, chilled and filtered, without booster</b>							
160	175	no	1x13A	2.20	N/A	450 x 470 x 335	28
<b>Boiling, chilled and filtered, with booster</b>							
240	175	yes	2x13A	2.20	2.20	450 x 470 x 335	28

**Note** Chilled water will continue to be dispensed after the rated capacity has been used, although this may affect the dispense temperature.

\*\*Add an extra 5-8 kg when full of water.

#### Min / Max water supply pressure

HydroTaps and Mains All-in-One taps.....0.17 MPa (1.7 bar) - 0.7 MPa (7 bar)

Mixer taps and Vented All-in-One taps.....0.2 MPa (2 bar) - 0.7 MPa (7 bar)

Booster and scale filtration.....0.2 MPa (2 bar) - 0.7 MPa (7 bar)

## Before installation



### Before installation ensure that the following have been provided at the installation site

- Review of all the technical specifications.
- Ensure the under counter cupboard floor can support the product weight when full of water (allow an extra 5-8kg when full).
- Sufficient space in the cupboard to install the Command-Centre™ and other components in accordance with these installation instructions. See Technical specification, page 9 for dimensions. Make allowance for a booster if required. See sections 2 to 4, pages 13 to 21 for installation instructions.
- For Zip HydroTap®G4 models without booster, 1 x 220-240V AC 13A socket will be required.  
For Zip HydroTap®G4 models with booster, 2 x 220-240V AC 13A sockets will be required.  
(One socket is for the Command-Centre™ and the other for the booster).
- Both the Command-Centre™ and booster must be installed in accordance with IEE regulations, See Technical specification, page 9 for power ratings.

**Note** Check all cable and hose lengths against inlet /outlet positions before proceeding (see sections 2 to 4, pages 13 to 21 for general layout).

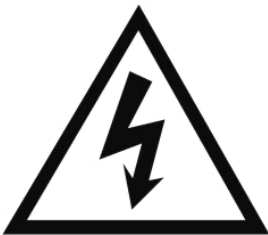

- A potable water supply connection with isolating valve inside the cupboard within reach of the braided hoses and positioned so that the connection point and the stop cock will not be obstructed when the Command-Centre™ is installed.
- For the All-in-One 'Mains' models an external hot and cold water supply is required.
- If an external filtration or water softening device is required, then it is important to allow extra space for these items.
- A potable cold water supply with a minimum working pressure of:  
(see page 9 min. / max. water supply pressure).
- If pressure is likely to exceed 0.7 MPa (7 bar), install a 0.35 MPa (3.5 bar) pressure limiting valve.
- The appliance must be placed with its base in a horizontal position.

**IMPORTANT!** Do not proceed with the installation if these requirements are not met.

# Section 1 Ventilation

When installing air flow vents, the following tools will be required

- Jigsaw and drill.
- Keyhole or wall board saw.

## 1.1 Preferred ventilation arrangement shown below.

The ducted vent kit supplied with the Command-Centre™ exhausting through the kick-space should be used, to provide adequate ventilation in all conditions. (Ancillary components are not shown in these diagrams).

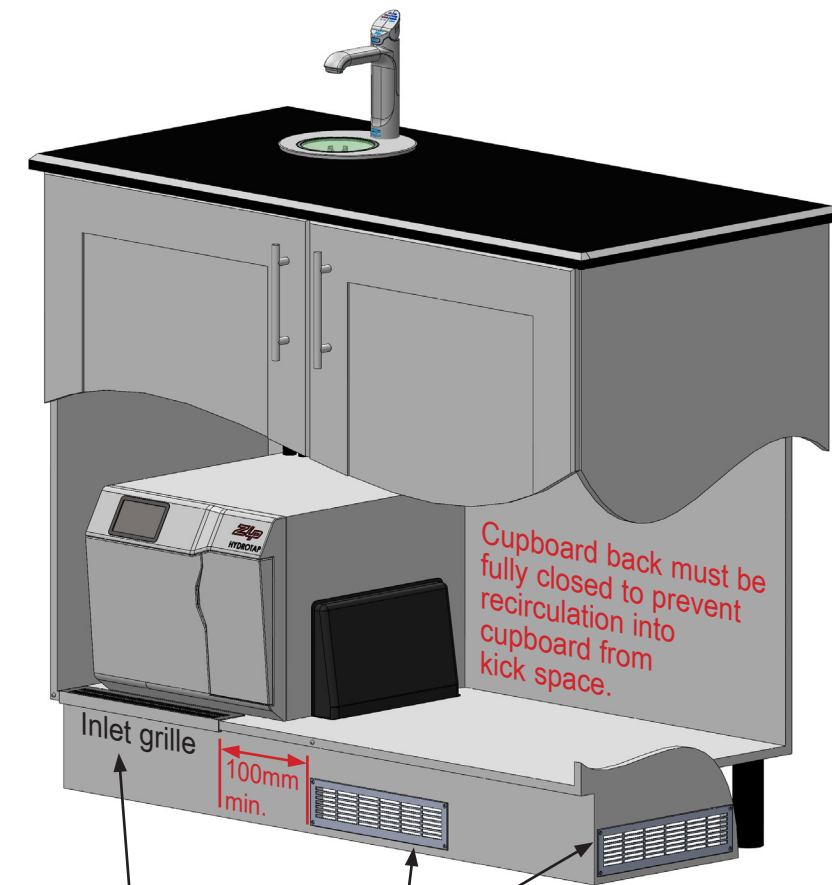

Inlet grille should be fitted in baseboard

Position vent grille on either the kick board or the cupboard ends

### Vent cut-out details

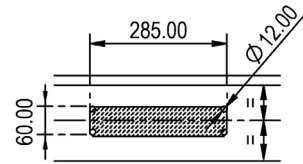

**A Air outlet vent**

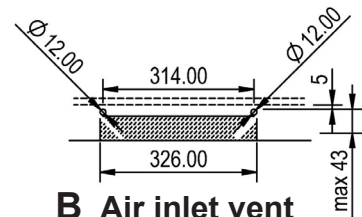

**B Air inlet vent**

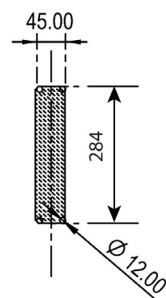

**C Ducted vent**

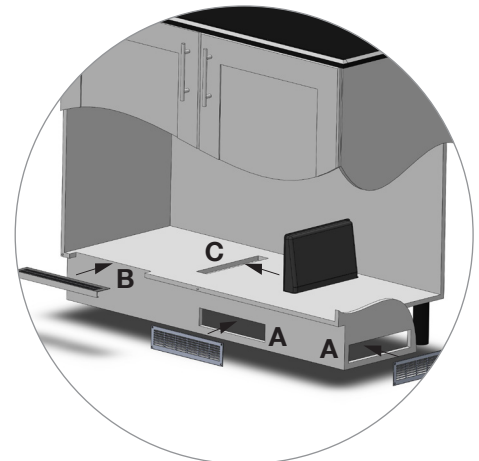

**Important** See section 4 Command-Centre™ installation, pages 17 to 21.

## Ventilation

### 1.2 Alternative arrangement (Dual fan kit)

In situations where the preferred arrangement cannot be used or will not work effectively e.g.

- Single cupboard where the 100mm grille spacing cannot be achieved.
- Where there are openings in the back of the cupboard allowing exhaust air to recirculate into the cupboard space.

An SP93156 Dual exhaust fan kit\* must be fitted in either arrangement A or B shown below and connected to the DIN socket on the Command-Centre™.

**A** Fan kit fitted to kick board and with kick space duct fitted to the Command-Centre™.

**B** Fan kit fitted to cupboard door (position **B1**) or side (position **B2**) and without kick space duct fitted to the Command-Centre™. \*For dual exhaust fan cut-out dimensions see the instructions provided with the kit.

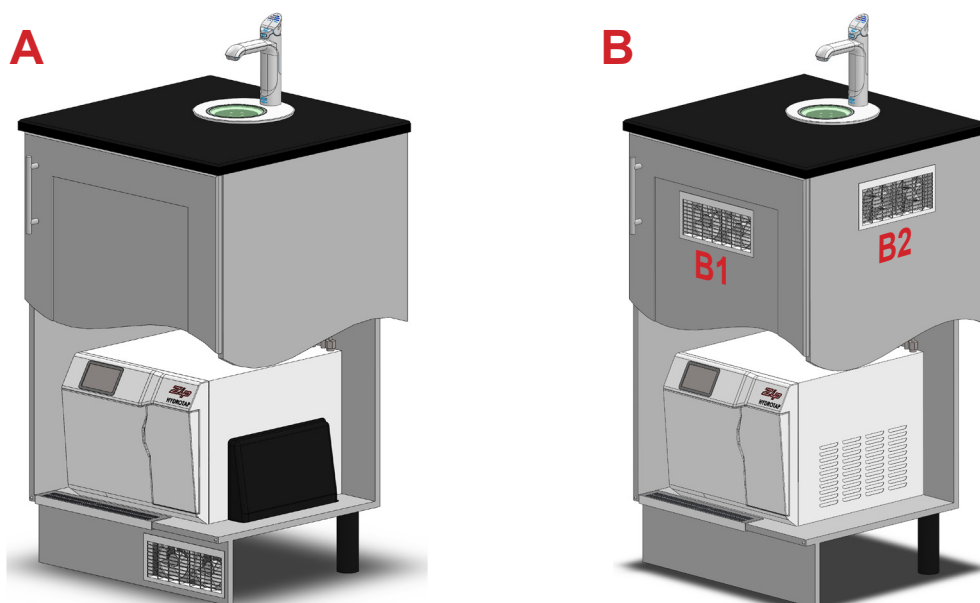

### 1.3 Alternative arrangement (Vent tray)

In situations where cupboard width is 1000mm or greater, without central pillar and where vent grilles cannot be fitted in the kick board (e.g. hospitals).

- Use the Vent tray kit.
- The flat vent grille, supplied should be used as an inlet vent and fitted to the cabinet side (adjacent to the Command-Centre air inlet) or angled inlet grille fitted in baseboard, if 100 mm separation from Vent tray exhaust can be achieved.

Position a vent grille in the cupboard end or inlet grille on the baseboard

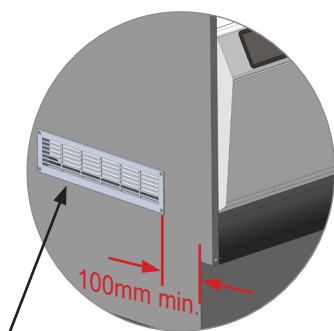

Inlet grille should be fitted on baseboard

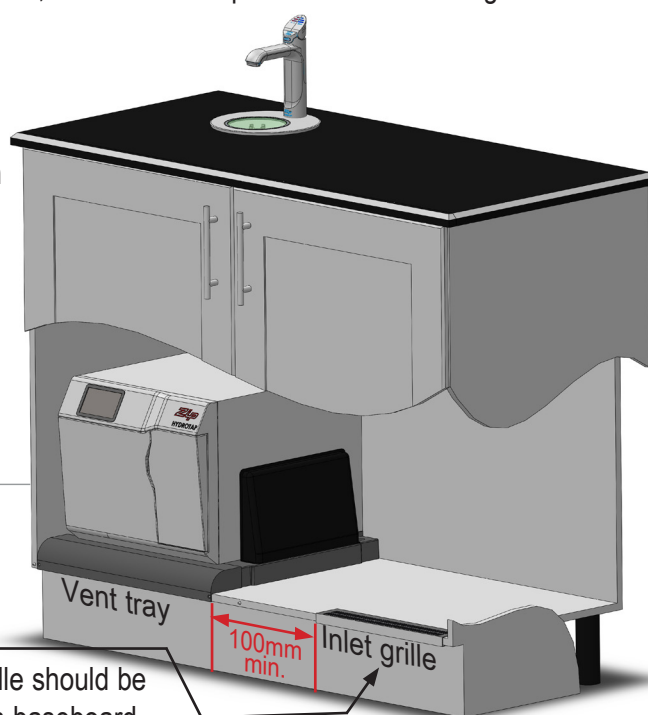

# Section 2

## Booster system

### 2.1 Product description

The booster system is a compact electronically controlled auxiliary water heater. It is intended to provide pre-heating of water before it enters the Zip HydroTap®G4 boiling tank. If the booster is used the boiling water output will increase from 160 to 240 167ml cups/hour.



**Note 1** Water connection  
blue cap - water in  
red cap - water out.  
The braided hoses cannot be lengthened.

**Note 2** The electrical cable length is 0.6m.

**Note 3** Position the booster within reach of the fixed hose lengths, keeping the booster as close as possible to the Command-Centre™ inlet / outlet connections.

**Note 4** Ensure the booster is mounted in an upright position (as shown) with a horizontal base.

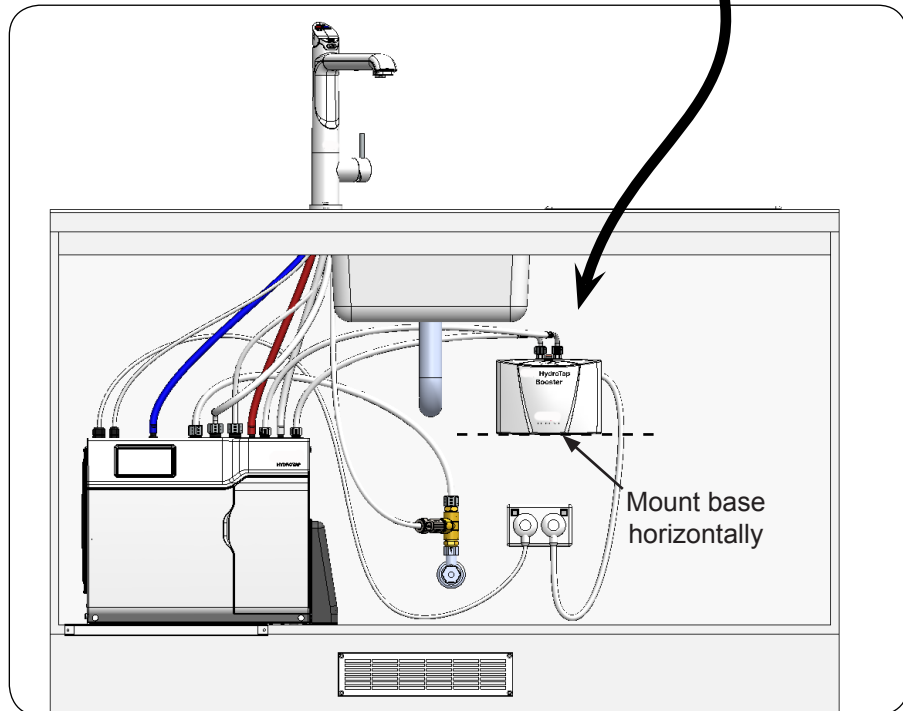

**Note 5** Before you install a booster, determine whether an external water filter / softener is required. If an external water filter / softener is required, the external bypass valve must be set correctly, see page 17.

### Booster specifications

	Rating	Unit
Nominal power rating	2.2	kW
Nominal current	10	A
Electricity supply 50Hz AC	230	V
Electrical flex, white - 0.6m nom. length	13	A
Fixed flow rate	1.2	L/min

## Booster installation

### 2.2 Installation procedure

#### Site requirements

- Booster must only be installed in a frost-free area. Never expose booster to frost.
- The booster is designed for wall mounted installation and must be installed with water connectors facing upwards.
- The booster is protected against water ingress to class IP 25.
- The 500mm braided hoses supplied with the booster cannot be lengthened.
- The 90° elbow hose ends should be fitted to the inlet and outlet connections on top of the booster.
- The hot water outlet hose must be thermally insulated with the insulation provided.

### 2.3 Booster installation see diagrams below

- To remove the mounting chassis, insert a flat blade screwdriver all the way into the lock.
- Gently angle the screwdriver upwards by approximately 10°.
- Pull the booster forwards by approximately 15°.
- Carefully pull the booster upwards to complete the removal process. Take care not to break the lower clips.
- Attach the mounting chassis horizontally to the wall / cupboard wall.
- To install, clip the booster into the on the mounting chassis and snap into position (see installation below).

**Note** Remove the wall mounting chassis from the rear of the booster for wall mounting.

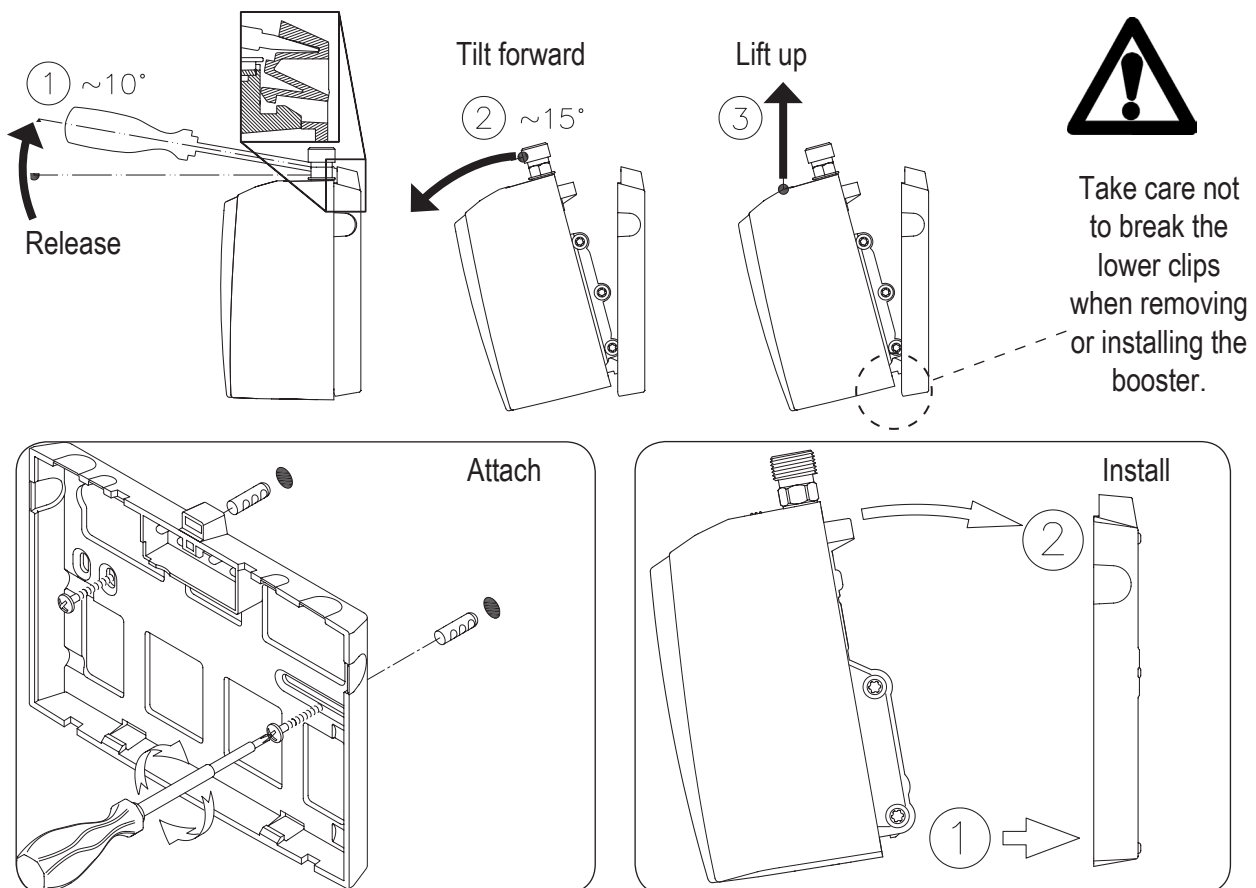

## Booster system

**Note 1** This appliance is intended for use with the Zip HydroTap®G4 Command-Centre™

**Note 2** Water connections must be pointing vertically upwards.

**Note 3** The booster unit should be installed as close as possible to the Zip HydroTap®G4 as the 500mm connection hoses cannot be lengthened.

### 2.4 Braided hose connections

- The cold water inlet (blue cap) and hot water outlet (red cap) are marked on the rating plate. Connect the braided hoses from the 'BYPASS OUT' fitting on the Command-Centre™ to the water inlet of the booster (blue cap) and from the outlet of the booster (red cap) to the 'BYPASS IN' fitting on the Command-Centre™. Avoid exerting mechanical force on the booster. This can be achieved by using a spanner on the flats of the inlet and outlet connections when tightening the braided hose connectors. Do not over-tighten ! Tighten the braided hoses by hand, then turn a further 90° to 180° with a spanner.
- Once the water connections have been made, check for any leaks and rectify as necessary.

Typical installation

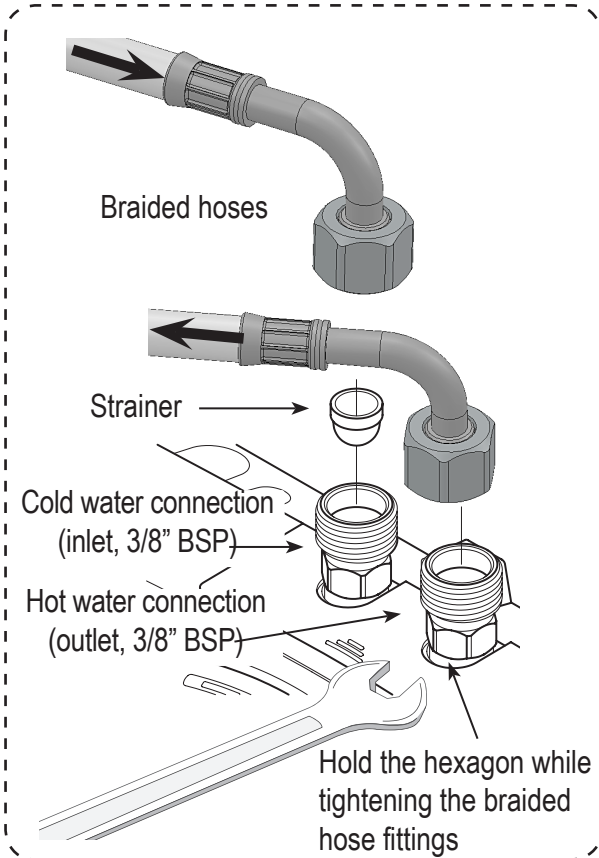
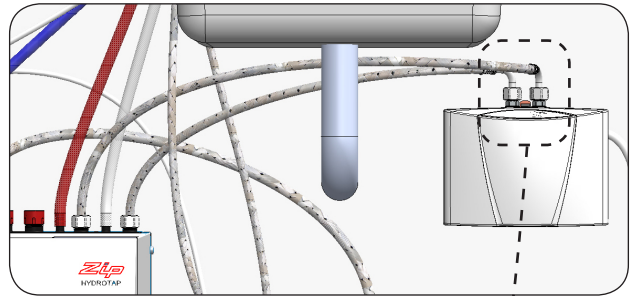







# Section 4

## Command-Centre™ installation

### 4.1 External bypass valve

The diverter bypass valve allows the user to choose to have the boiling feed water bypass the internal filter and only be filtered by the external filtration. This diverter valve is located at the rear panel of the Command-Centre™, see the diagram below.

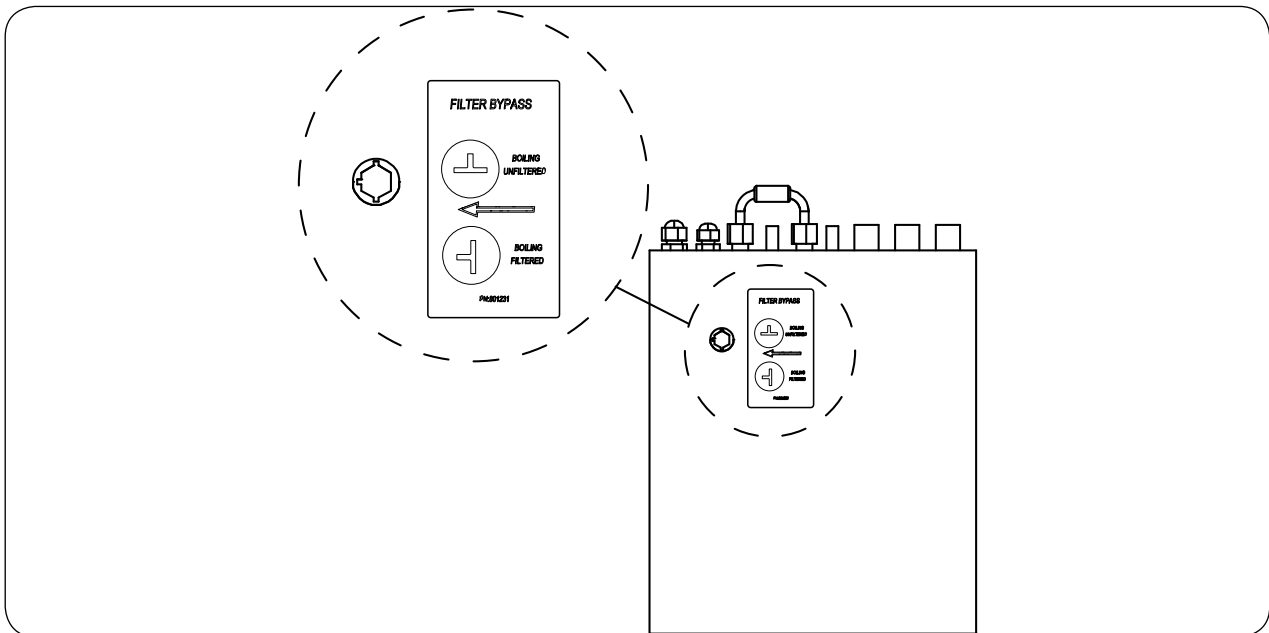

Check the table below to determine which filter bypass position you need for your product.

If no external filter is installed, select position A

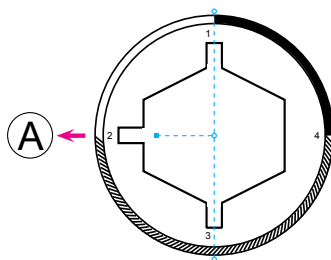

If an external filter is installed, select position B

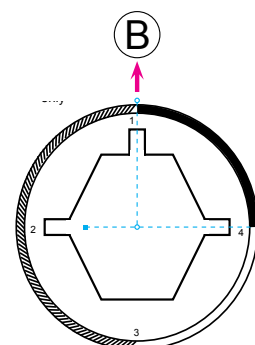

Leave in position **A** until after commissioning (section 4). Select position **B** if scale filter is fitted, before flushing the scale filter as described on page 16.

### 4.2 Braided hose fitting

Install the mains water braided hoses to the Command-Centre™ before locating in place.

# Installation instructions

**4.3 HydroTap®G4 models** Refer to 803341UK Tap installation instructions (for Arc / Cube also refer to the tube kit assembly instructions) supplied with the tap.



Elite

Classic

Arc / Cube

**Note** All silicon tubes / plastic pipes must be cut to size. They must have a constant fall back to the Command-Centre™

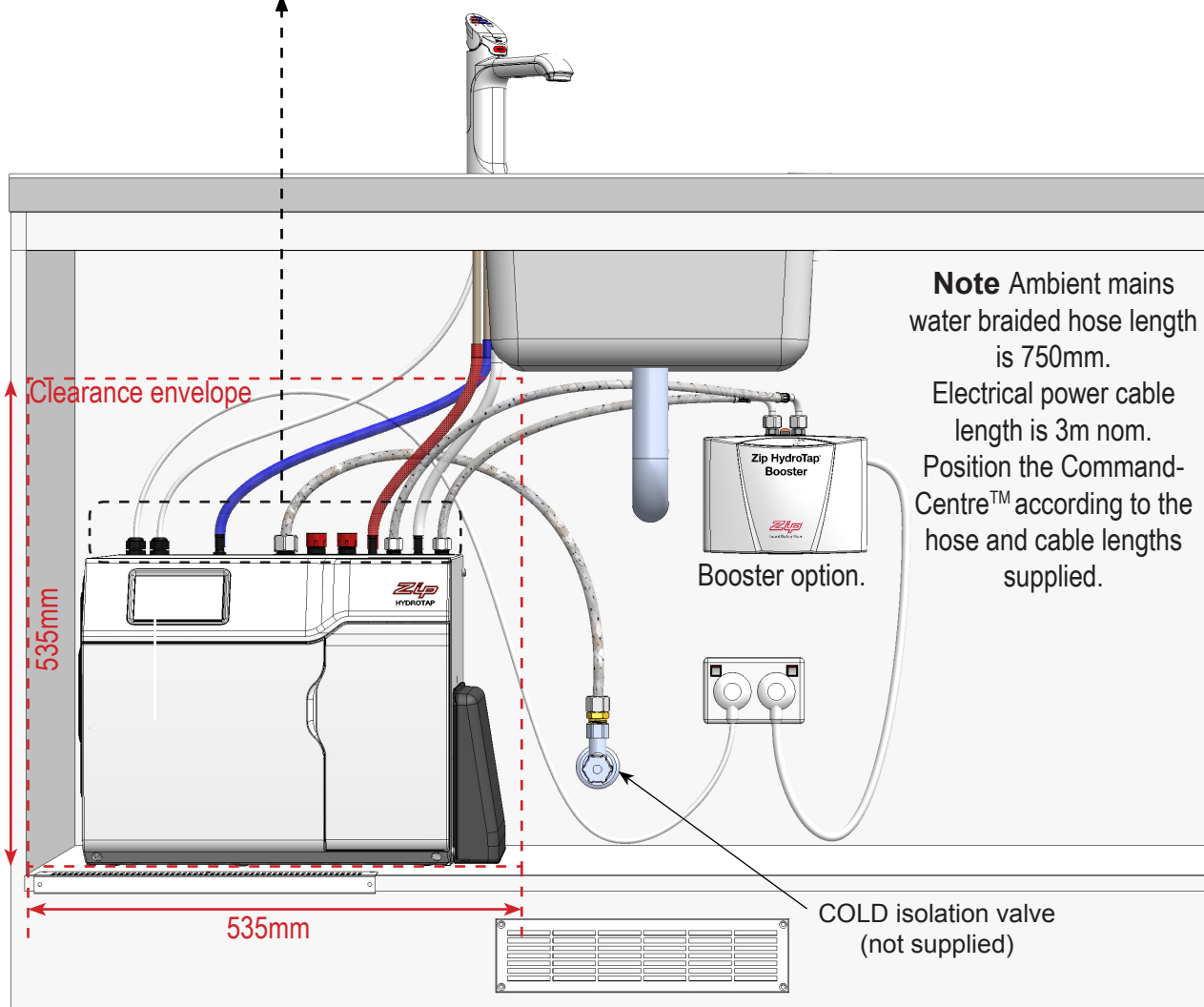
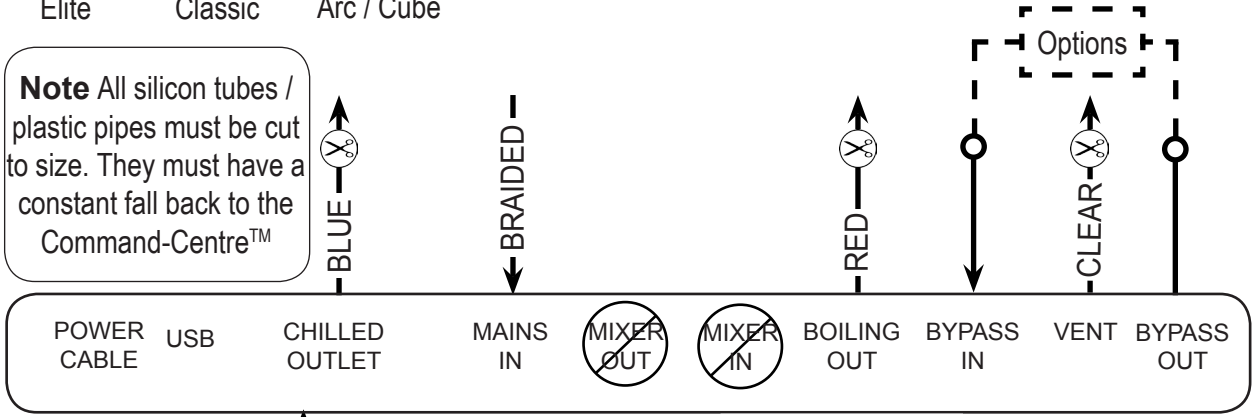

**Note** Ambient mains water braided hose length is 750mm.  
Electrical power cable length is 3m nom.  
Position the Command-Centre™ according to the hose and cable lengths supplied.

**Note** The braided hoses and connection tubes supplied with the tap head assembly and cold inlet CANNOT be lengthened. Also ensure that the (factory fitted) bypass tube assembly is fitted in place if the booster and / or external filter are not used.

⊘ Not required for HydroTap®G4 models.

# Installation instructions

## 4.4 HydroTap®G4 and mixer tap combinations Refer to 803341UK Tap installation instructions (for Arc / Cube also refer to the tube kit assembly instructions) supplied with the tap.

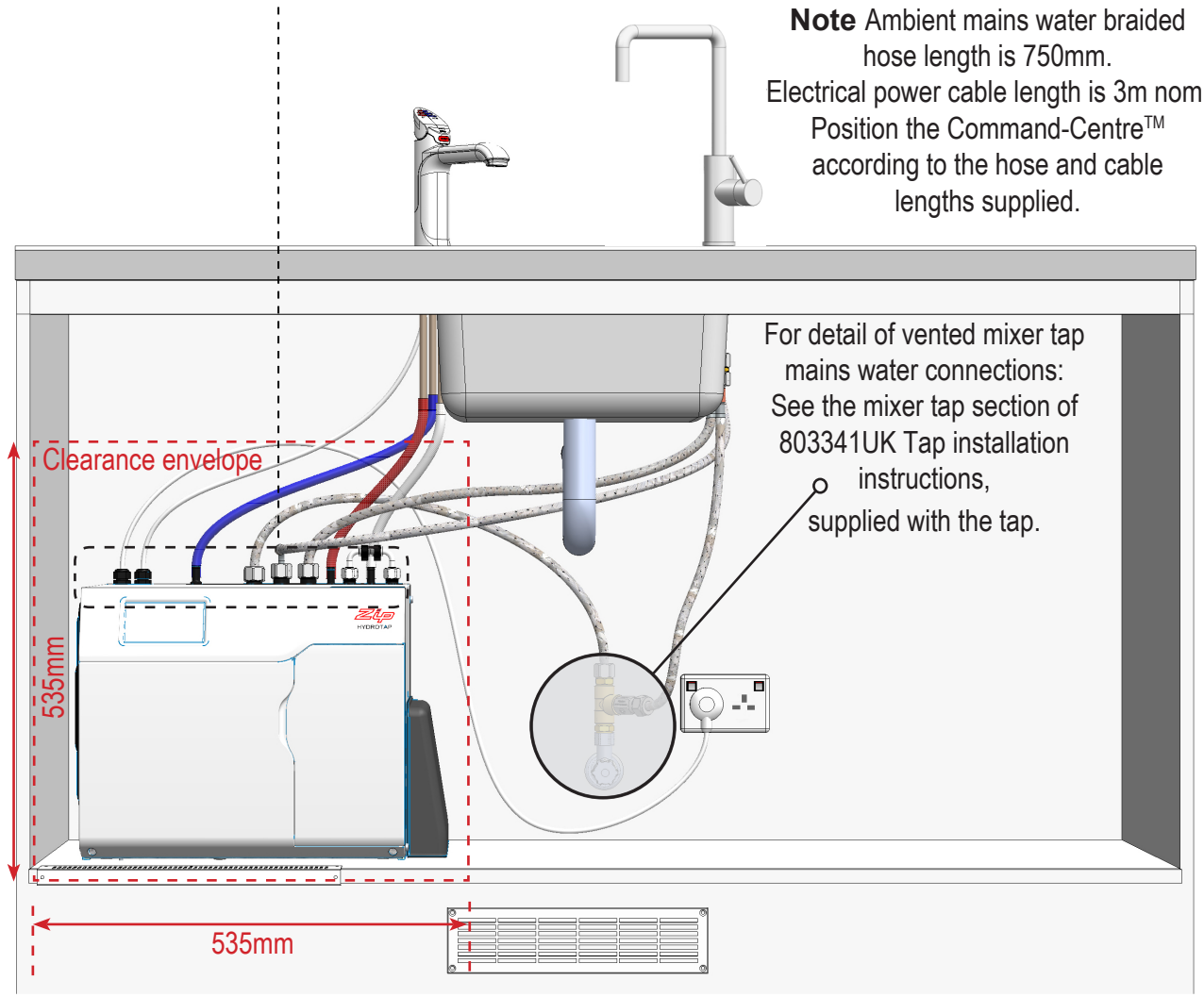
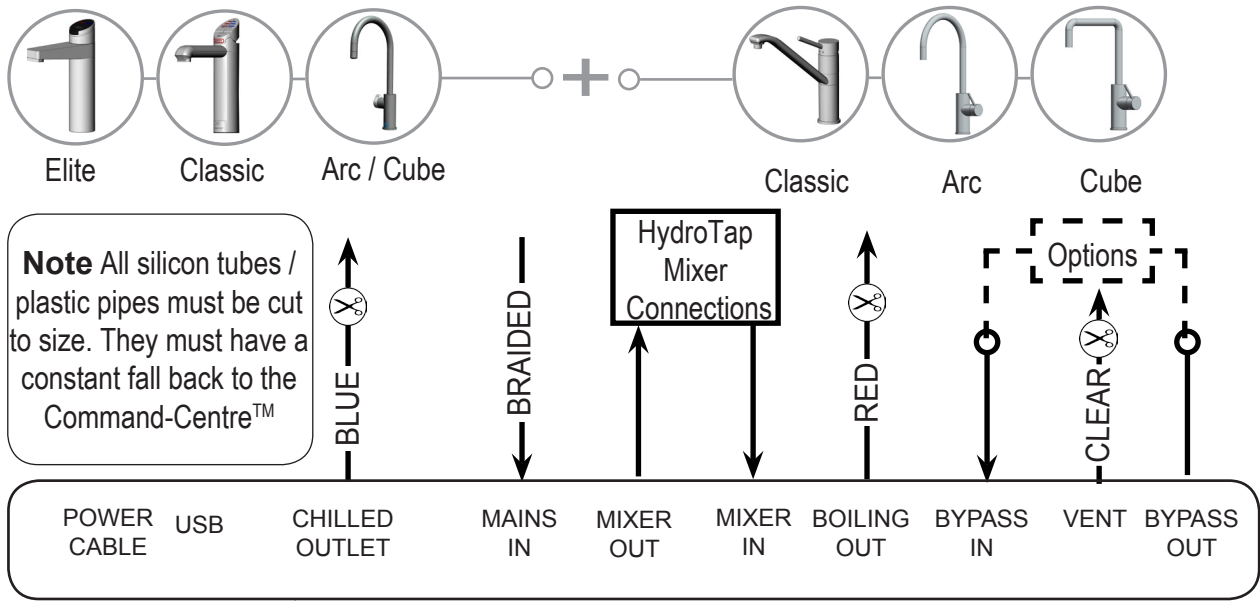

**Note** The braided hoses and connection tubes supplied with the tap head assembly and cold inlet CANNOT be lengthened. Also ensure that the (factory fitted) bypass tube assembly is fitted in place if the booster and / or external filter are not used.

# Installation instructions

**4.5 All-in-One 'Mains' tap** Refer to 803341UK Tap installation instructions (for Arc / Cube also refer to the tube kit assembly instructions) supplied with the tap.

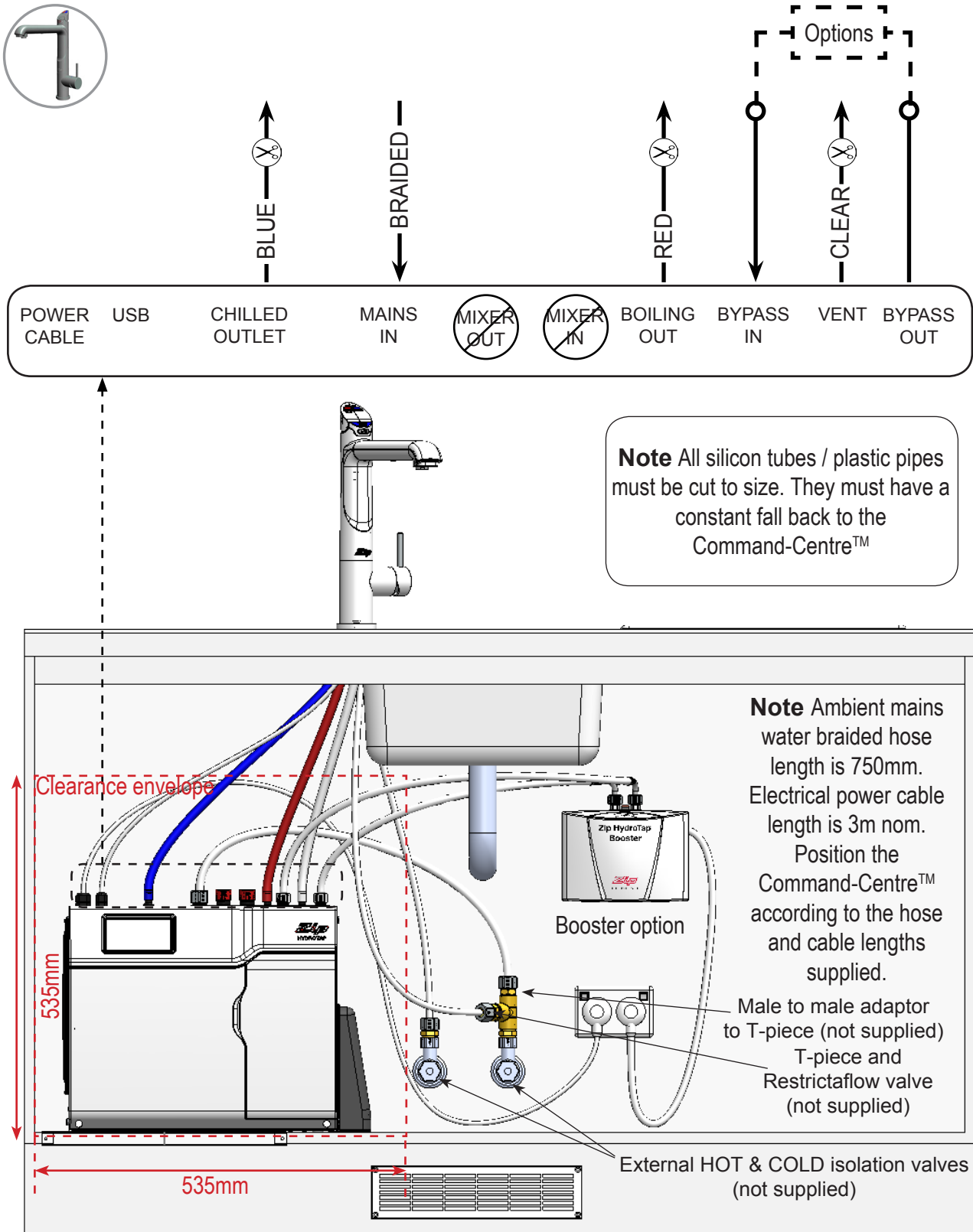

**Note** The braided hoses and connection tubes supplied with the tap head assembly and cold inlet CANNOT be lengthened. Also ensure that the (factory fitted) bypass tube assembly is fitted in place if the booster and / or external filter are not used.

⊘ Not required for standard AIO 'Mains' HydroTap®G4 models.

# Installation instructions

**4.6 All-in-One 'Vented' tap** Refer to 803341UK Tap installation instructions (for Arc / Cube also refer to the tube kit assembly instructions) supplied with the tap.



**Note** All silicon tubes / plastic pipes must be cut to size. They must have a constant fall back to the Command-Centre™

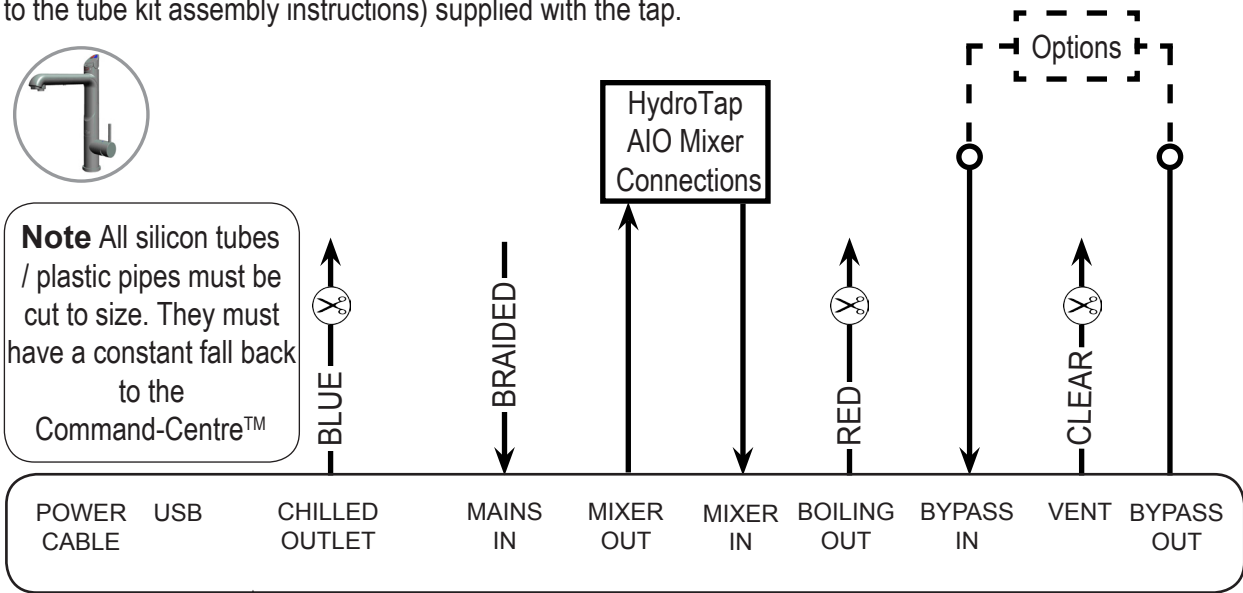

**Note** Ambient mains water braided hose length is 750mm. Electrical power cable length is 3m nom. Position the Command-Centre™ according to the hose and cable lengths supplied.

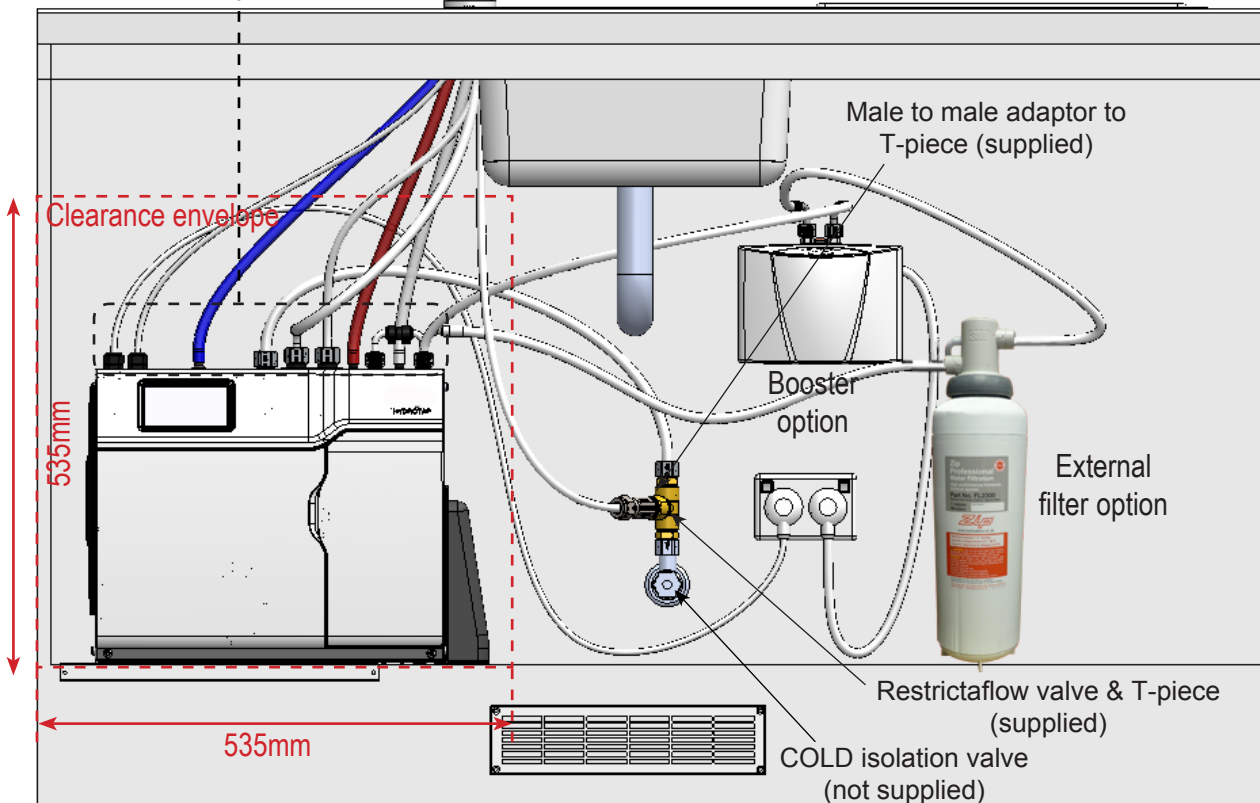

**Note** The braided hoses and connection tubes supplied with the tap head assembly and cold inlet CANNOT be lengthened. Also ensure that the (factory fitted) bypass tube assembly is fitted in place if the booster and / or external filter are not used.

# Section 5 Commissioning

The HydroTap®G4 is now ready to be commissioned.

- Turn the power and water on and check for any leaks.
- If fitted, ensure the booster is turned off. (The booster is commissioned later, see page 23).
- Familiarise yourself with the operation of the tap, in preparation for use, see the user guide.
- Follow the installation instructions below (and read section C of the user guide).
- After commissioning, the system may be customised by selecting further options in section G - settings of the user guide.

## 5.1 Select the language

Initial commissioning screen

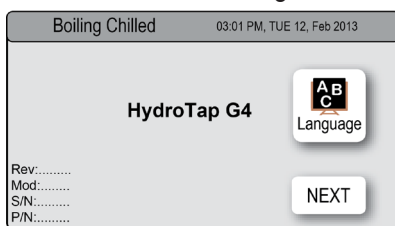

Language selection screen

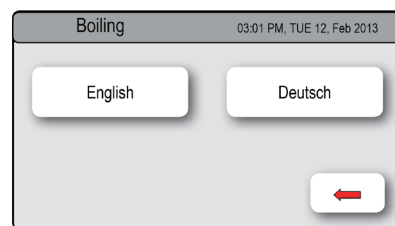

## 5.2 Filter flush

Have a bucket or similar container (not supplied) at the ready to hold a quantity of water that will be ejected while the filter flush mode is in operation. Open the filter access door on the front of the HydroTap®G4 and the filter cartridge will be exposed. Located to the rear right hand side of the cartridge is a flush line, approx 600mm long and the flush line stop cock. Place the free end of the flush line into the bucket or container (not supplied). **Note** At first commissioning, the system will select the filter flush screen automatically.

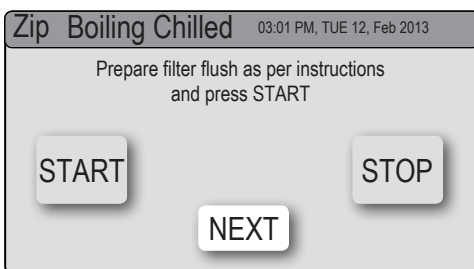
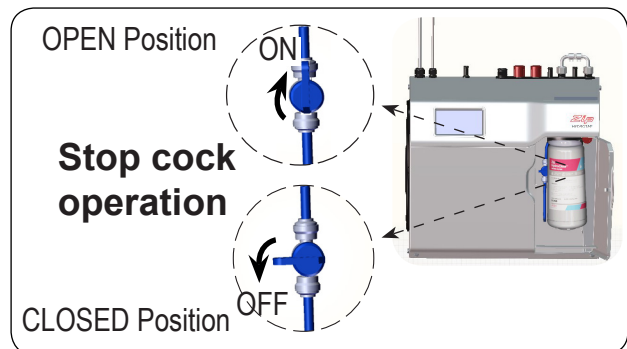

- Press [START] / [STOP] button to start and stop the filter flush.
- Turn the flush stop cock on.
- Allow at least 10 litres of water to flush through the filter.
- Once the filter flush is finished, Turn the stop cock off then press [STOP] to end filter flush mode.
- Press [NEXT] for the flow calibration screen.
- Press the [START] button and the tank will first empty then fill. Upon completion the pulse count will be displayed. Check the value is within limits.
- Press [NEXT] for the boiling calibration screen.

## 5.3 Flow calibration

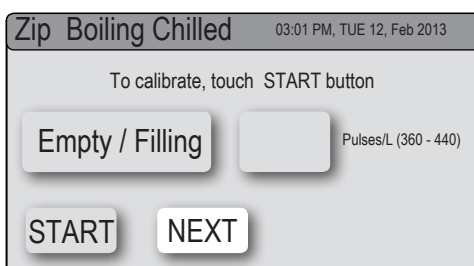

**Note** For any subsequent filter changes or any operational procedures, please refer to the HydroTap®G4 user guide, located inside the filter housing access door.

## Commissioning

### 5.4 Boiling calibration (boiling models)

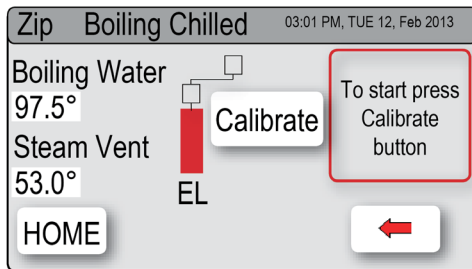

- Press the [Calibrate] button and the system will start the boiling calibration procedure. This will take approx. 5 to 6 minutes.

### 5.5 To enable a booster, when installed.

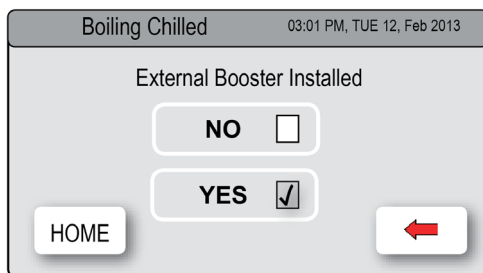

- Press the [MENU] button for main menu.
- Press the [Install] button.
- Press the [Boost] button.
- In the next screen, select [YES] to enable the booster.
- Before connecting the power to the booster, water must be run through for a min. of 30 seconds to purge. Run the boiling tap for 30 seconds and the allow the tank to refill.
- Dispense boiling water for 30 seconds and check the booster outlet hose is warm when the boiling water tank is replenishing.

**Note** For any subsequent filter changes or any operational procedures, please refer to the user guide, located inside the filter housing access door.

**Note** Depending on your location you may need to reset the internal clock. See section G of the user guide to reset the date and time.

### 5.6 Safety sensor calibration (boiling models)

Light intensity varies from site to site, therefore it is recommended that a re-calibration be performed at the time of the installation.

All direct sunlight must be shaded from the HydroTap®G4, during the calibration. This can be achieved by closing any nearby curtains, blinds, etc.

#### Procedure

- Shield the HydroTap®G4 from direct sunlight.
- In normal operating mode. Turn the power off.
- Pull both tap levers to the forward position.
- Turn the power on.
- The safety sensor will calibrate.
- Return the levers to the neutral position.

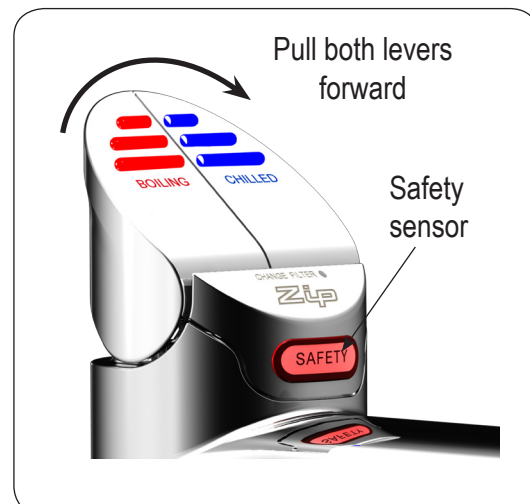



## Trouble shooting

<b>System fault message</b>	<b>Possible cause</b>	<b>Solutions</b>
Power Board Fault	Electrical disruption	Check power supply and all fuses
Interface Fault	Internal fault	Call Zip Service
Level Board Fault	Internal fault	Call Zip Service
Condenser Screen Blocked	Blocked air filter	Remove blockage / clean filter / check user guide
Water leak, Isolate Mains	Water leak	Turn off mains water supply / call for service
Compressor Over Run	Compressor too hot	Check ventilation
Water Supply Failure	No water	Check water supply is turned ON
Hot Sensor Open	Internal fault	Call Zip Service
Hot Sensor Closed	Internal fault	Call Zip Service
Cold Sensor Open	Internal fault	Call Zip Service
Cold Sensor Closed	Internal fault	Call Zip Service
Flood Sensor Open	Internal fault	Call Zip Service
Condenser Sensor Closed	Internal fault	Check ventilation / call Zip Service
Condenser Sensor Open	Internal fault	Check ventilation / call Zip service
Heater Fuse / Driver Fault	Internal fault	Call Zip Service
Heater Driver Fault	No hot water	Call Zip Service
Compressor Driver Fault	No chilled water	Call Zip Service
Hot Sensor Degraded	Internal fault	Call Zip Service
Condenser Overtemp	Blocked air filter	Remove blockage / clean filter / check user guide
A DC Pump is faulty	Internal fault	Call Zip Service
Steam too Cool	Internal fault	Call Zip Service
Steam Sensor Open	Internal fault	Call Zip Service
Steam Sensor Closed	Internal fault	Call Zip Service
Hot Tank Over filled	Internal fault	Call Zip Service
Comp Fuse/Driver Fault	Internal fault	Call Zip Service
Hot Tank Under filled	Low water pressure	Check water supply
Boil Dry Protection	Safety activated	Turn OFF/ON power to reset
Flash Memory corrupted	Internal fault	Call Zip Service
Flow Sensor Fault	Internal fault	Call Zip Service

Call an electrician, a plumber, or Zip on 0345 6 005 005 for assistance, service, spare parts or enquiries.



## End of life disposal



The use of this crossed out wheeled bin logo indicates that this product needs to be disposed of separately to any other household waste.

Within each of the European Union member countries, provisions have been made for collection and recycling of unwanted electrical and electronic equipment. In order to help preserve our environment we ask that you dispose of this product correctly. Please contact Zip Customer Service on 0345 6 005 005 for advice.

## Warranty

Certain warranties may be implied by law into your contract with Zip. The warranty provided below is additional to these implied warranties and nothing set out below shall limit your statutory rights or rights at law. Zip Heaters (UK) warrants that, should the hot tank fail within five years of installation subject to satisfactory maintenance and registration of the product, or any part fail within two years of installation, the part will be repaired or replaced free of charge by Zip, its distributor or service provider, (except as set out below), provided the appliance is installed and used strictly in accordance with the instructions supplied, and that failure is not due to accident, misuse, abuse, unsuitable water conditions, or to any alteration, modification or repair by any party not expressly nominated by Zip.

No costs are payable by the customer other than any mileage or travelling-time charges incurred by a Zip service provider or the cost of removal, cartage and re-installation of any component of the appliance if it needs to be returned for repair to Zip or its distributor.

This warranty does not cover damage resulting from non-operation of the appliance, the use of non authorised parts or consequential damage to any other goods, furnishings or property.

No warranty applies to the life of any filtration cartridge installed with the appliance as cartridge life may vary according to water quality and the rate of water consumption.

Zip does not exclude, restrict or modify any liability that cannot be excluded, restricted or modified or which cannot, except to a limited extent, be excluded, restricted or modified as between the owner or user and Zip under the laws applicable.

Furthermore this warranty does not displace any statutory warranty, but, to the extent to which Zip is entitled to do so, the liability of Zip under any statutory warranty will be limited at Zip's option to the replacement of the appliance or supply of equivalent appliance, the payment of the cost of replacing the appliance or acquiring an equivalent appliance, or the payment of the cost of having the appliance repaired or the repair of the appliance.

HydroTap®G4 residential models are designed specifically for use in a domestic environment and inappropriate installations such as in a commercial location will invalidate the warranty.

Registering your purchase.

Registering your Zip installation on the Zip website may help to establish date of installation should it become necessary to service the appliance under terms of the Zip warranty. To register your installation go to [www.zipwater.com/uk](http://www.zipwater.com/uk) and look under the heading "Warranty".

## Notes

## Notes

## Contact Details

### Head Office

Zip Water UK  
14 Bertie Ward Way  
Dereham  
Norfolk  
NR19 1TE

Website: [www.zipwater.com/uk](http://www.zipwater.com/uk)  
Email: [sales@zipindustries.co.uk](mailto:sales@zipindustries.co.uk)  
Facsimile: 01362 692 448  
Telephone: 0345 6 005 005



The standard cup referred to in this publication is 167 ml (6 fl oz).  
The standard glass is 200 ml (7 fl oz).  
The terms "Zip" and "HydroTap" are registered trade marks of Zip Heaters (Aust) Pty Ltd.  
Zip products described in this publication are manufactured under one or more of the following patents: AU675601, AU637412, AU635979, GB0422305, GB2065848, US4354049, US5103859, US5099825 and SA2006/08043. Other patents are in force and patent applications are pending.

