

Zip HydroTap® G4

Filtered boiling and chilled drinking water for the home.

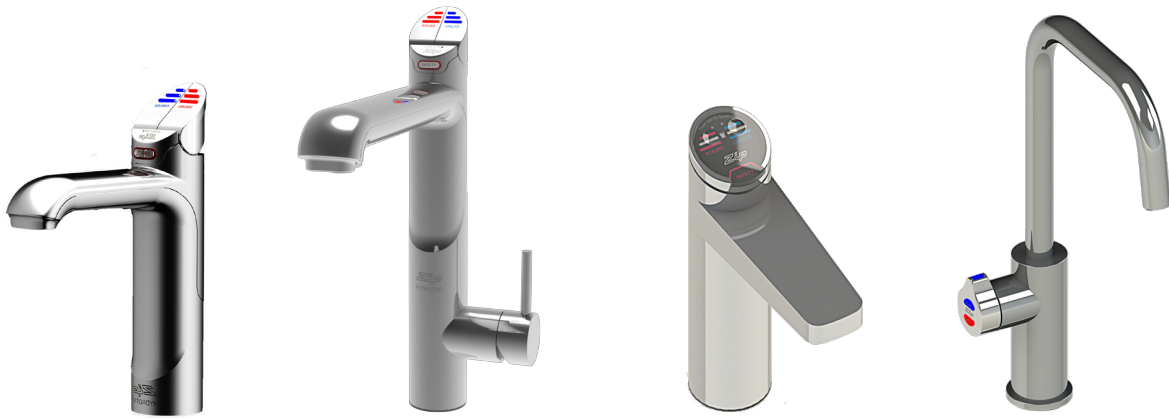

Affix model number label
here
802253UK



Tap options

The G4 series offers a range of interchangeable taps to suit the customer's needs



Classic HydroTap®G4 range



Arc / Cube range

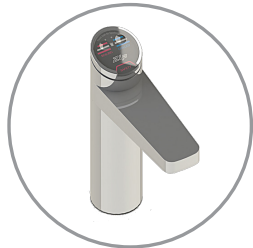

Elite range



Mixer range

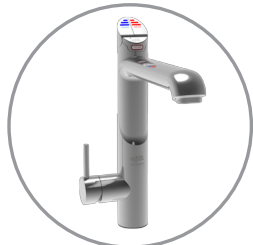

All-in-One range

These standalone taps are directly compatible with the G4 Command-Centre™.

The mixer tap range may be used in conjunction with any of the above to provide mixed hot and cold water for sanitary use.

The All-in-One tap may be used as alternatives to any of the above combinations.

Index

HydroTap®G4 specifications

| | |
|---|----|
| Installation check list | 4 |
| General product features | 5 |
| Important safety instructions | 6 |
| Warnings and regulatory information | 7 |
| Major components and accessories..... | 8 |
| Technical specifications | 9 |
| Before installation and site requirements | 10 |

Installation instructions

Step 1 - Measure and cut all the tap holes before fitting the taps: Refer to 803341UK Tap installation instructions supplied with the tap head.

Step 2 - Check for adequate ventilation.

Section 1- Ventilation.

| | |
|--------------------------------------|----|
| 1.1- Ventilation for all models..... | 11 |
|--------------------------------------|----|

Step 3 - Install the booster and / or filter / softener (if required).

Section 2 - Booster installation.

| | |
|---|----|
| 2.1- Booster specifications and descriptions..... | 12 |
| 2.2- Installation procedure..... | 13 |
| 2.3- Booster installation..... | 13 |
| 2.4- Braided hose connections..... | 14 |

Section 3- Filter / softener installation

| | |
|---|----|
| 3.1- Filter / softener installation | 15 |
|---|----|

Step 4 - Install the Command-Centre™.

Section 4 - Command-Centre™ installation.

| | |
|--|----|
| 4.1- Check the external bypass valve setting | 16 |
| 4.2- Fit the mains water supply hose | 16 |
| 4.3- HydroTap®G4 models | 17 |
| 4.4- HydroTap®G4 and mixer tap combinations..... | 18 |
| 4.5- All-in-One 'Mains' tap | 19 |
| 4.6- All-in-One 'Vented' tap | 20 |

Step 5 - Commission the HydroTap®G4.

Section 5 - Commissioning.

| | |
|-------------------------------------|----|
| 5.1- Select language | 21 |
| 5.2- Filter flush | 21 |
| 5.3- Flow calibration | 21 |
| 5.4- Boiling calibration..... | 22 |
| 5.5- Booster activation | 22 |
| 5.6- Safety sensor calibration..... | 22 |

Trouble shooting

| | |
|-----------------------------|----|
| Trouble shooting table..... | 23 |
| End of life disposal | 23 |
| Warranty..... | 24 |
| Contact details | 24 |

Installation checklist

Before installation

- Read the instructions and check if there is adequate space to install all of the components.
- **Note** Not all fittings are supplied with the appliance kit. Isolation valves are not supplied.
- Check the mains water pressure is within min / max requirements (see page 9).
- Check the water quality to determine if extra filtration will be required.
- **Note** This product must be fitted to a potable water supply.
- Check the Command-Centre™ rating plate and ensure correct power is available.
- Check the under counter cupboard floor supporting the Command-Centre™ is adequate for its total weight, when full of water.

Before commissioning

- Check the system has been installed correctly.
- Check all plumbing fittings have been tightened.
- Ensure the outlet and vent pipes are positioned to drain correctly.
- Ensure there is adequate ventilation.
- Check all tubes and pipes from the Command-Centre™ to the tap have a constant rise and there are no sags or kinks in the hoses.
- Check all electrical connections are correct and there are no loose wires.

Commission (see section 5)

- Flush the supply line before connecting.
- Turn on the water and check for leaks.
- Flush the filter(s).
- Activate / enable the booster (if fitted).
- Calibrate the safety sensor for boiling models.
- Where applicable, programme the Command-Centre™ to suit the customer's requirements.

General product features

Thank you for purchasing a Zip HydroTap®G4. Please read and follow these instructions carefully to ensure safe and trouble free operation. If help and advice is required, please call 0345 6 005 005.

What is the Zip HydroTap®G4 ?

This Zip HydroTap®G4 is an electronically controlled, filtered, boiling and chilled water drinking system for the kitchen. The HydroTap®G4 systems are under counter drinking water appliances with a dispensing tap mounted on a sink or worktop, which has been designed for commercial applications. The HydroTap®G4 utilises a conventional refrigerant compressor to chill the water and an immersion heating element to boil the water. The boiling and chilled models will dispense boiling water (factory set to 98°C) chilled water (factory set to 6-10°C). These units are NOT designed to be used as sanitary fixtures.

The Zip HydroTap®G4 models which dispense boiling water are fitted with a tap mounted safety lock. In addition, there are various energy saving options accessible via the main menu. The system is equipped with a self-calibrating program which caters for altitude adjustment. The water filter is a disposable item which will require periodic replacement and is covered by a limited OEM warranty.

It is important that the installation be undertaken safely, correctly and completely in order to utilise all the benefits that the HydroTap®G4 can provide. HydroTap®G4 Classic taps can be ordered with the tap head assembly for disabled use. The disabled levers are supplied with Braille caps for the visually impaired.

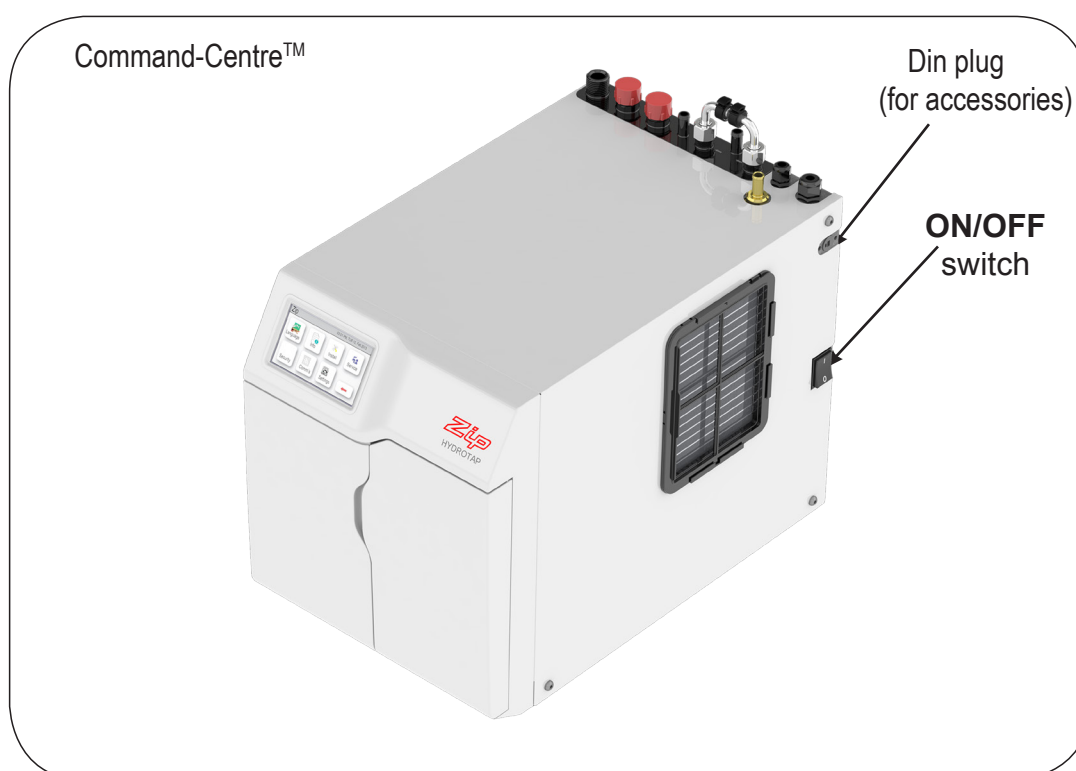

Important safety instructions

This manual contains important safety and installation instructions for the Zip HydroTap®G4. Please read all warnings, installation requirements and installation instructions before installing any Zip HydroTap®G4. This system must be installed in accordance with water supply byelaws, current IEE regulations and relevant local authority byelaws.



Safety

This appliance is not intended for use by persons (including children) with reduced physical, sensory or mental capabilities, or lack of experience and knowledge, unless they have been given supervision or instruction concerning the use of the appliance by a person responsible for their safety. Children should be supervised to ensure that they do not play with the appliance. Cleaning and user maintenance shall not be made by children without supervision.

Refrigerant

The Zip HydroTap®G4 Command-Centre™ contains R134A refrigerant under pressure. Maintenance of the refrigeration unit must be carried out by an accredited service provider or qualified refrigeration technician.

Qualifications

If the power cable is damaged it must be repaired only by a qualified technician. To avoid hazards, all installation procedures must be carried out by a suitably qualified tradesperson. The power cable and power outlet must be in a safe visible position for connection.

Venting

Sometimes steam and / or boiling water may discharge through a vent outlet on the tap. If the tap is not installed using the front pedestal, ensure the tap body is located so the tap outlet safely dispenses into the sink bowl area.

Lifting

Take care when lifting. The Command-Centre™ may exceed safe lifting limits. If you feel this is beyond your personal capabilities, please seek assistance with the lift. The weights of the Command-Centre™ is marked on the packaging. Do not lift the Command-Centre™ by the front cover or any of its connections. Refer to the technical specification, see page 9, for the weight of the product.

Airflow

The Zip HydroTap®G4 operates within the ambient temperature range 5°C - 35°C. Proper air circulation must be provided. The system will operate satisfactorily only if the recommended air gaps are provided. See Section 1 'Ventilation', page 11, for correct installation to prevent overheating. The vent kit supplied must be fitted.

Altitude

Water boils at varying temperatures at different altitudes. The HydroTap®G4 adjusts for this during startup calibration and will recalibrate itself on a regular basis.

Frost protection

If the HydroTap®G4 is located where the ambient air temperature could fall below 5°C when the heater is not in use, do not turn off the appliance electrically. This safeguard does not offer the same protection to the connecting pipework and fittings.

Positioning







It is important to ensure the Command-Centre™ is positioned in an accessible area close to the floor level. The Command-Centre™ must have its base mounted in a horizontal position with all inlets and outlets facing up. The tap must be located above the Command-Centre™. See Section 4, Command-Centre™ installation.





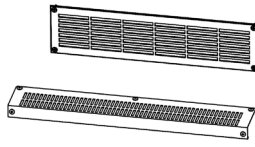

Warnings

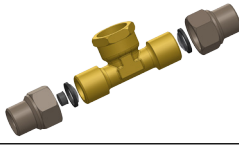
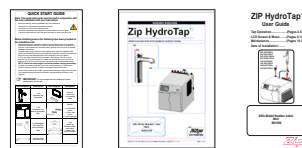
- ⚡ The Zip HydroTap®G4 must be earthed. The resistance of the earth connection from each exposed metal part must be less than 1Ω.
- All installation and service work must be completed by trained and suitably qualified tradespeople. Faulty operation due to unqualified persons working on this product, or any other Zip product may void warranty coverage.
- As the installer, it is your responsibility to supply (if necessary) and install all valves as required by local regulations and relevant standards.
- The HydroTap®G4 is rated for 230V 50Hz AC operation.
- Do not remove the cover of the appliance under any circumstances without first isolating the appliance from the power supply.
- Never locate the Command-Centre™ near, or clean with water jets.
- Do not expose the Zip HydroTap®G4 to the elements of nature.
- Due to the process of continuous improvement, Zip reserves the right to change details mentioned in this manual, without notice.
- Visit www.zipwater.com/uk to ensure you have the latest copy of this document.

Major components and accessories

| Parts supplied | Description |
|---|--|
| Tap options | |
|  | 1 x HydroTap® G4 Classic Elite or #Arc / Cube # (inc. Tube kit) |
|  | 1 x All-in-One HydroTap® G4 Mains or Vented |
|  | 1 x Mixer tap Classic, Arc or Cube |
| Command-Centre™ and components | |
|  | 1 x Outlet vent 1 x Inlet vent |
|  | 1 x Command-Centre™ with air and water filters |
|  | 1 x Mains water connection hose |
|  | 1 x Booster inc. connection hoses (supplied with vented All-in-One and mixer tap models) |
|  | 1 x Installation fittings (supplied with vented mixer tap models) |
|  | 1 x User guide and 1 x Quick start guide 1 x Installation instruction |

| Accessories | Description |
|--|---|
|  | Booster (inc. connection hoses) ZT011 |
|  | Scale filter installation kit *ZT200G4 Filter not included. |
|  | Font Arc / Cube 93441UK*** Font Classic / Elite 90915UK*** |
|  | Replacement internal 0.2 micron filter ZT402 |
|  | Disabled lever kit SP91560 (Classic HydroTap®) |
|  | Mixer upgrade *** SP91546 Classic SP93413 Arc SP93414 Cube |
|  | All-in-One upgrade*** SP93332 (vented) SP93331 (mains) |
|  | Recommended water block HE45004 |

*ZT200G4 kit to fit filters

*** Chrome finish part numbers are shown, alternative finishes are available.

Technical specifications

Residential Boiling Chilled HydroTap® G4 range

HydroTap®s

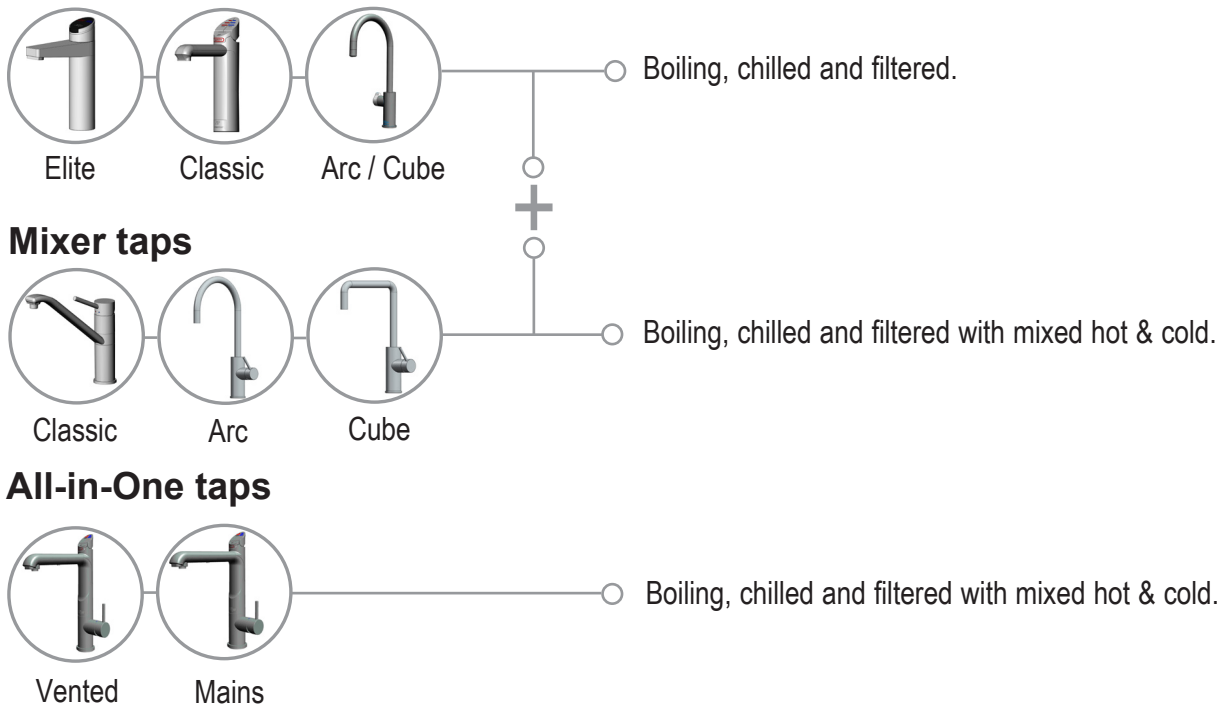

Specifications

| Boost (10A) | 13A sockets required | Power Rating (kW) 230V | Boost Rating (kW) 230V | Unit Dimensions W x D x H (mm) with air duct | **Dry Weight (kg) |
|---|----------------------|------------------------|------------------------|--|-------------------|
| Boiling, chilled and filtered, without booster | | | | | |
| no | 1x13A | 1.55 | N/A | 280 x 470 x 335 | 21 |
| Boiling, chilled and filtered, with booster | | | | | |
| yes | 2x13A | 1.55 | 2.20 | 280 x 470 x 335 | 21 |

Note Chilled water will continue to be dispensed after the rated capacity has been used, although this may affect the dispense temperature.

**Add an extra 4-5 kg when full of water.

Min / Max water supply pressure

HydroTaps and Mains All-in-One taps.....0.17 MPa (1.7 bar) - 0.7 MPa (7 bar)
 Mixer taps and Vented All-in-One taps.....0.2 MPa (2 bar) - 0.7 MPa (7 bar)
 Booster and scale filter.....0.2 MPa (2 bar) - 0.7 MPa (7 bar)

Before installation



Before installation ensure that the following have been provided at the installation site

- Review of all the technical specifications.
- Ensure the under counter cupboard floor can support the product weight when full of water (allow an extra 4-5kg when full).
- Sufficient space in the cupboard to install the Command-Centre™ and other components in accordance with these installation instructions. See technical specification, page 9 for dimensions. Make allowance for a booster if required. See sections 2 to 4, pages 12 to 20 for installation instructions.
- For Zip HydroTap®G4 models, 1 x 220-240V AC 13A socket will be required. For Zip HydroTap®G4 models with booster, 2 x 220-240V AC 13A sockets will be required.
(One socket is for the Command-Centre™ and the other for the booster).
- Both the Command-Centre™ and booster must be installed in accordance with IEE regulations. See Technical specification, page 9 for power ratings.

Note Check all cable and hose lengths against inlet /outlet positions before proceeding (see sections 2 to 4, pages 12 to 20 for general layout).

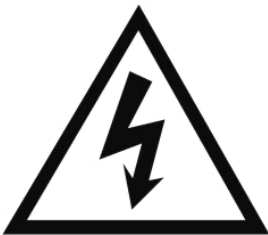

- A potable water supply connection with isolating valve inside the cupboard within reach of the braided hoses and positioned so that the connection point and the stop cock will not be obstructed when the Command-Centre™ is installed.
- For the All-in-One 'Mains' models an external hot and cold water supply is required.
- If an external filtration or water softening device is required, then it is important to allow extra space for these items.
- A potable cold water supply with a minimum working pressure of:
(see page 9 min. / max. water supply pressure).
- If pressure is likely to exceed 0.7 MPa (7 bar), install a 0.35 MPa (3.5 bar) pressure limiting valve.
- The appliance must be placed with its base in a horizontal position.

IMPORTANT! Do not proceed with the installation if these requirements are not met.

Section 1

Ventilation

1.1 Ventilation for all models

- The clearance envelope dimensions stated in the specification sheets and installation instructions must be observed.
- Adequate ventilation must be provided to ensure that the cupboard space temperature does not exceed 35°C.

1.2 Preferred arrangement

- 4mm door buffers (at the four corners of each door) supplied with the Command-Centre™ should be used to provide adequate ventilation in normal usage, see illustration below.

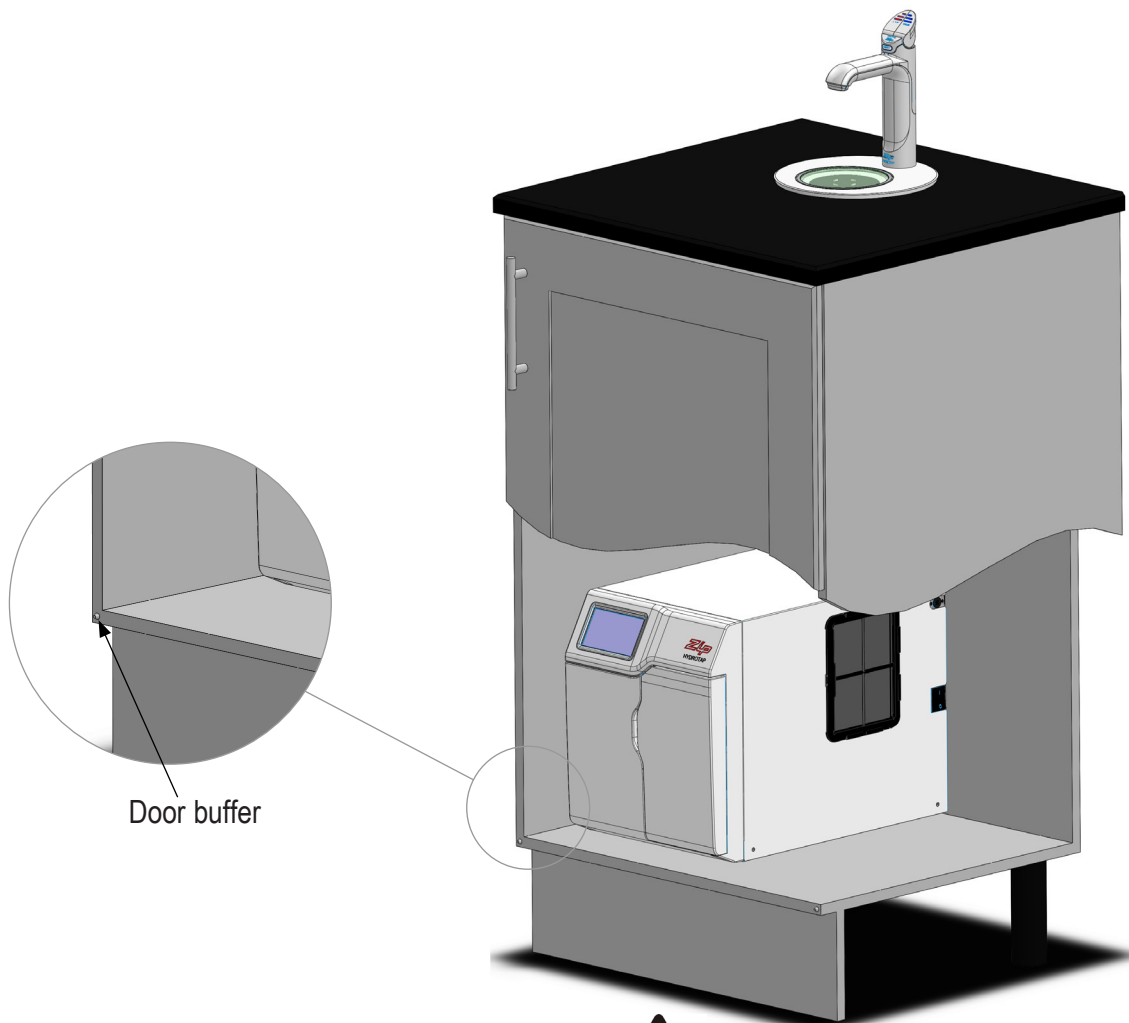

Important See section 4 Command-Centre™ installation, pages 16 to 20.

Section 2

Booster system

2.1 Product description

The booster system is a compact electronically controlled auxiliary water heater. It is intended to provide pre-heating of water before it enters the Zip HydroTap®G4 boiling tank. The booster is used to present approx. 55°C hot water for sanitary use to a secondary outlet with additional “Vented Mixer” kit.



Note 1 Water connection
blue cap - water in
red cap - water out.
The braided hoses cannot be lengthened.

Note 2 The electrical cable length is 0.6m.

Note 3 Position the booster within reach of the fixed hose lengths, keeping the booster as close as possible to the Command-Centre™ inlet / outlet connections.

Note 4 Ensure the booster is mounted in an upright position (as shown) with a horizontal base.

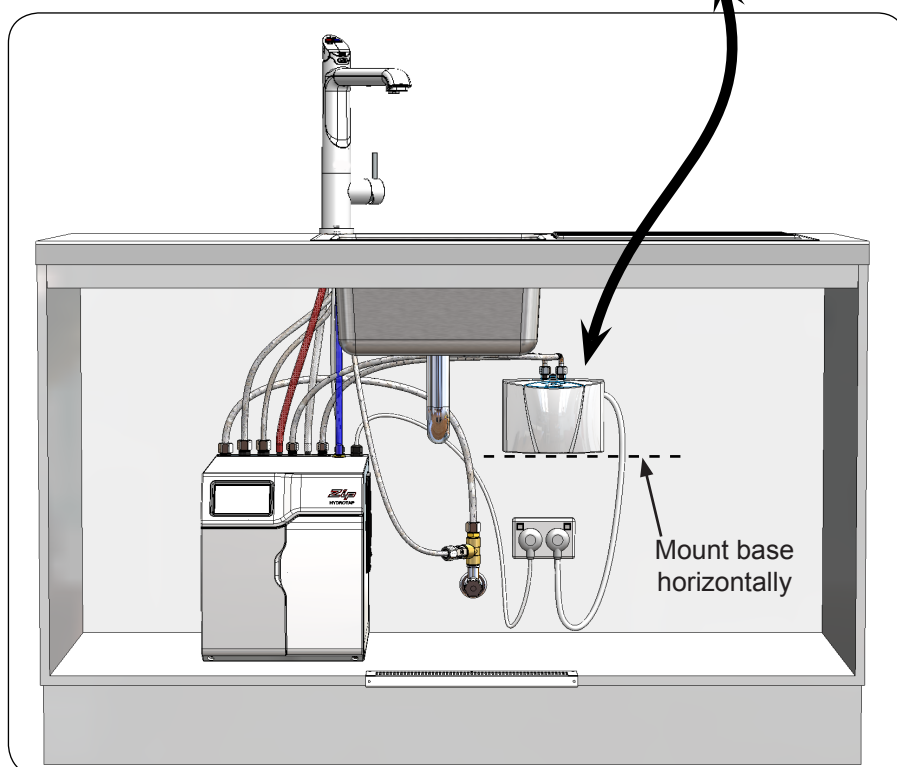

Note 5 Before you install a booster, determine whether an external water filter / softener is required. If an external water filter / softener is required, the external bypass valve must be set correctly, see page 16.

Booster specifications

| | Rating | Unit |
|---|--------|-------|
| Nominal power rating | 2.2 | kW |
| Nominal current | 10 | A |
| Electricity supply 50Hz AC | 230 | V |
| Electrical flex, white - 0.6m nom. length | 13 | A |
| Fixed flow rate | 1.2 | L/min |

Booster installation

2.2 Installation procedure

Site requirements

- Booster must only be installed in a frost-free area. Never expose booster to frost.
- The booster is designed for wall mounted installation and must be installed with water connectors facing upwards.
- The booster is protected against water ingress to class IP 25.
- The 500mm braided hoses supplied with the booster cannot be lengthened.
- The 90° elbow hose ends should be fitted to the inlet and outlet connections on top of the booster.
- The hot water outlet hose must be thermally insulated with the insulation provided.

2.3 Booster installation see diagrams below

- To remove the mounting chassis, insert a flat blade screwdriver all the way into the lock.
- Gently angle the screwdriver upwards by approximately 10°.
- Pull the booster forwards by approximately 15°.
- Carefully pull the booster upwards to complete the removal process. Take care not to break the lower clips.
- Attach the mounting chassis horizontally to the wall / cupboard wall.
- To install, clip the booster into the on the mounting chassis and snap into position (see installation below).

Note Remove the wall mounting chassis from the rear of the booster for wall mounting.

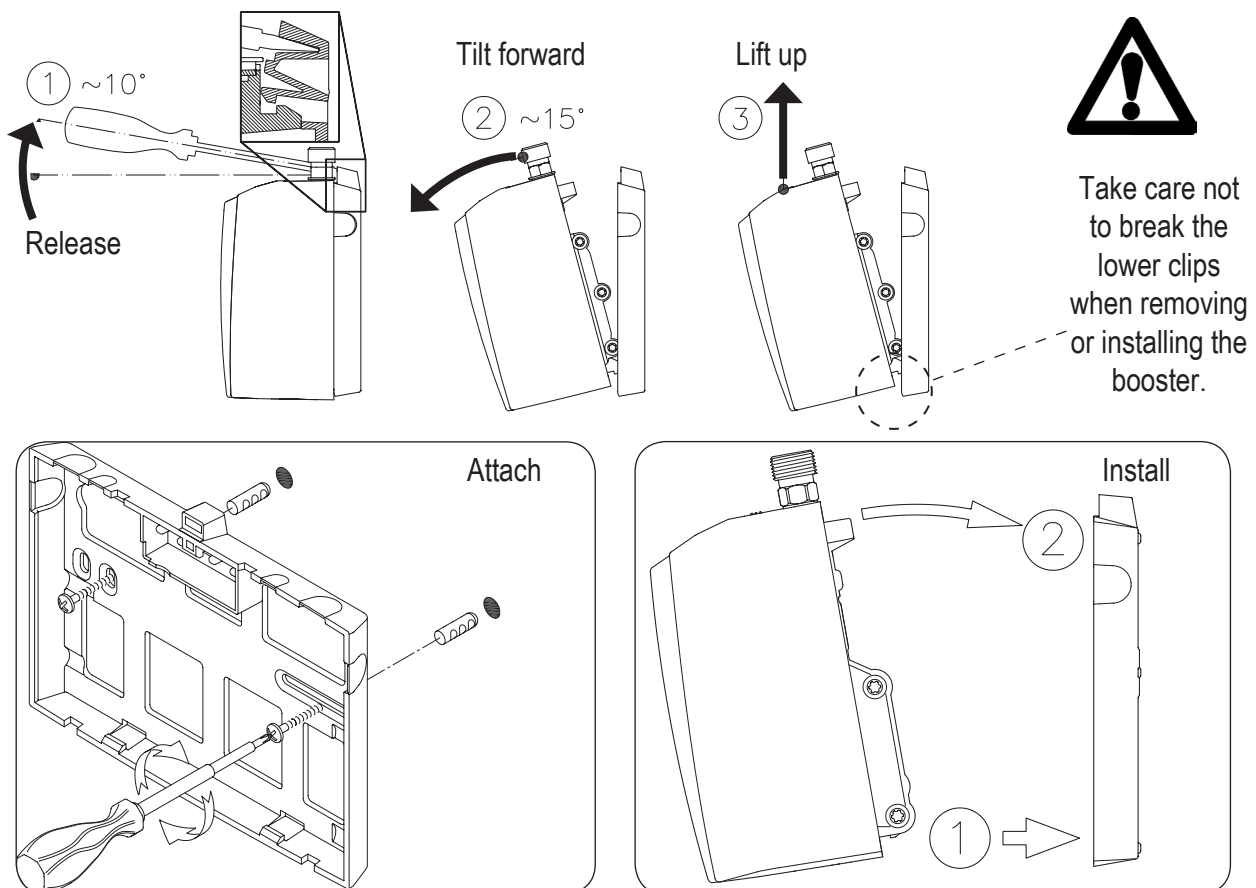

Booster system

Note 1 This appliance is intended for use with the Zip HydroTap®G4 Command-Centre™

Note 2 Water connections must be pointing vertically upwards.

Note 3 The booster unit should be installed as close as possible to the Zip HydroTap®G4 as the 500mm connection hoses cannot be lengthened.

2.4 Braided hose connections

- The cold water inlet (blue cap) and hot water outlet (red cap) are marked on the rating plate. Connect the braided hoses from the 'BYPASS OUT' fitting on the Command-Centre™ to the water inlet of the booster (blue cap) and from the outlet of the booster (red cap) to the 'BYPASS IN' fitting on the Command-Centre™. Avoid exerting mechanical force on the booster. This can be achieved by using a spanner on the flats of the inlet and outlet connections when tightening the braided hose connectors. Do not over-tighten! Tighten the braided hoses by hand, then turn a further 90° to 180° with a spanner.
- Once the water connections have been made, check for any leaks and rectify as necessary.

Typical installation

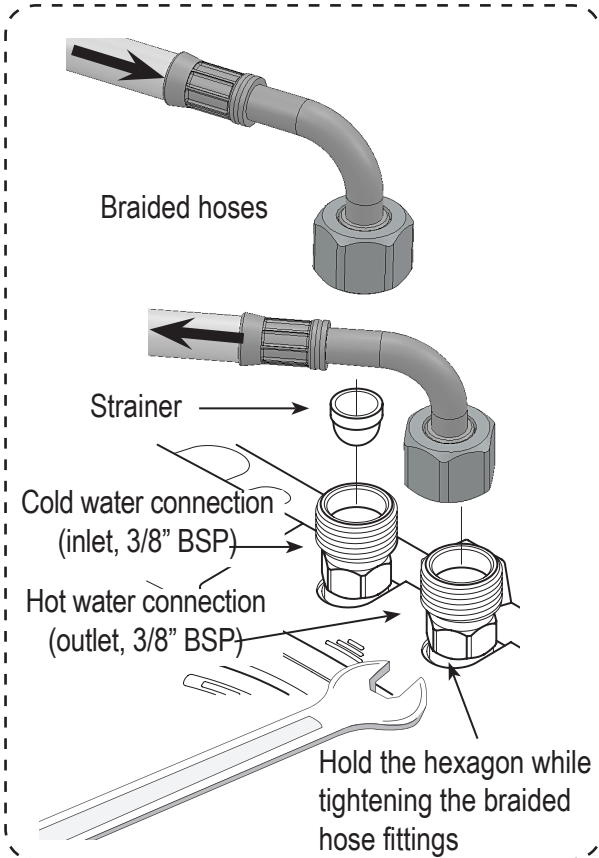
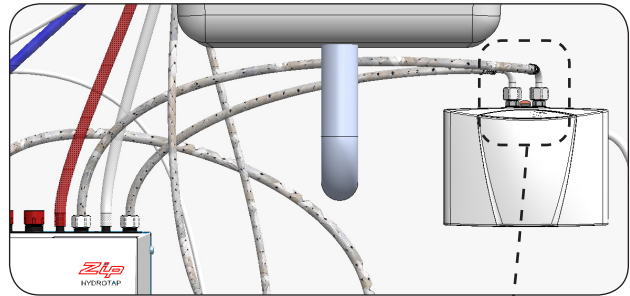

Section 3 Filter / softener installation

An external filter / softener may be fitted to reduce the incidence of scale build up in the hot tank or may be supplied at the customer's request. (Scale filter head fitting kit order code ZT200G4).

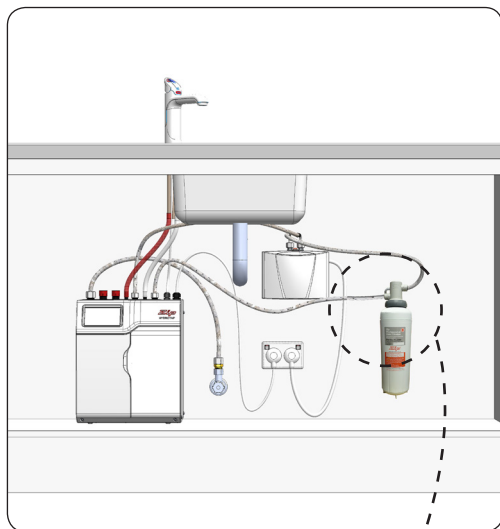

3.1 Mounting the filter head

- Choose a suitable location, (cupboard back or side wall) within the reach of the braided hoses.
- Mount the filter head bracket in an upright position, using the screws supplied in the ZT200G4 kit.
- Ensure there is enough headroom for the filter cartridge to be easily fitted and removed. *Allow a min. 80mm base clearance.
- Attach the hoses as adjacent diagram, noting the flow directions as marked on the filter head.

3.2 Cartridge installation and flush.

- Remove the sanitary cap from the new cartridge and make sure the o-rings are correctly positioned.
- Moisten o-rings with water. Do not use any petroleum products to lubricate the o-rings.
- Install cartridge with a quarter turn anticlockwise until cartridge comes to a complete stop.
- Cartridge installation is complete.

Note The following instructions to flush the filter must be undertaken AFTER commissioning of the complete HydroTap®G4 system, see section 5, Commissioning, page 21.

- Disconnect the braided hose from the filter outlet on the filter head (out arrow) & insert the filter flush pipe (plastic pipe). Direct the pipe into a container of greater than 10 litre capacity.
- Turn the mains water supply on.
- Use the HydroTap®G4 to dispense boiling water. After a short time water will flush through the filter into the container.
- Allow 10 litres of water to flush through.
- Turn the mains water supply off.
- Remove the filter flush pipe (plastic pipe) from the filter outlet, and refit the braided hose from the Command-Centre™.
- Turn the mains water supply on.
- If a booster is fitted, turn the power to the booster off and use the HydroTap®G4 boiling lever to dispense water for 30 seconds, allow the tank to refill.
- Turn the power to the booster on and dispense boiling water for a further 30 seconds.
- The filter / softener flush is complete.



Section 4

Command-Centre™ installation

4.1 External bypass valve

The diverter bypass valve allows the user to choose to have the boiling feed water bypass the internal filter and only be filtered by the external filtration. This diverter valve is located at the rear panel of the Command-Centre™, see the diagram below.

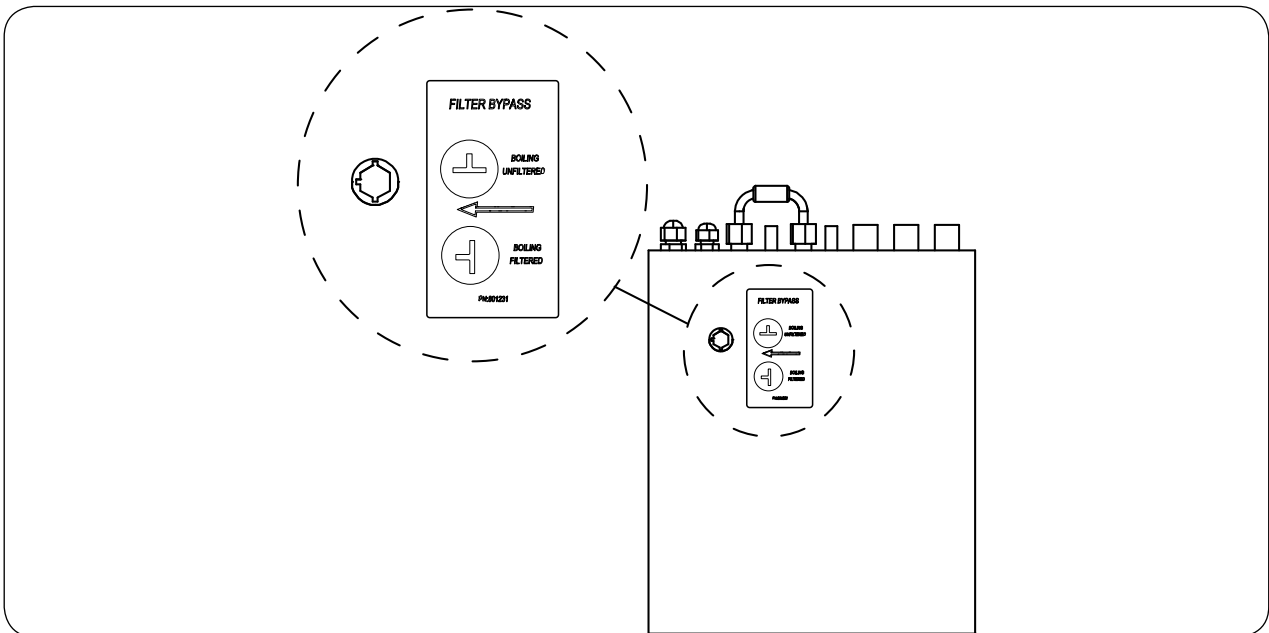

Check the table below to determine which filter bypass position you need for your product.

If no external filter is installed, select position A

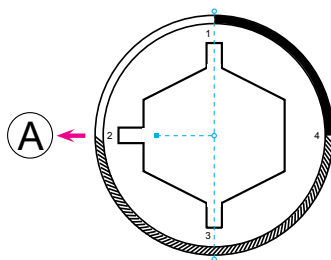

If an external filter is installed, select position B

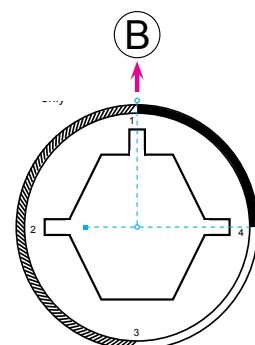

Leave in position **A** until after commissioning (section 5). Select position **B** if scale filter is fitted, before flushing the scale filter as described on page 15.

4.2 Braided hose fitting

Install the mains water braided hoses to the Command-Centre™ before locating in place.

Installation instructions

4.3 HydroTap®G4 models Refer to 803341UK Tap installation instructions (for Arc / Cube also refer to the tube kit assembly instructions) supplied with the tap.



Elite Classic Arc / Cube

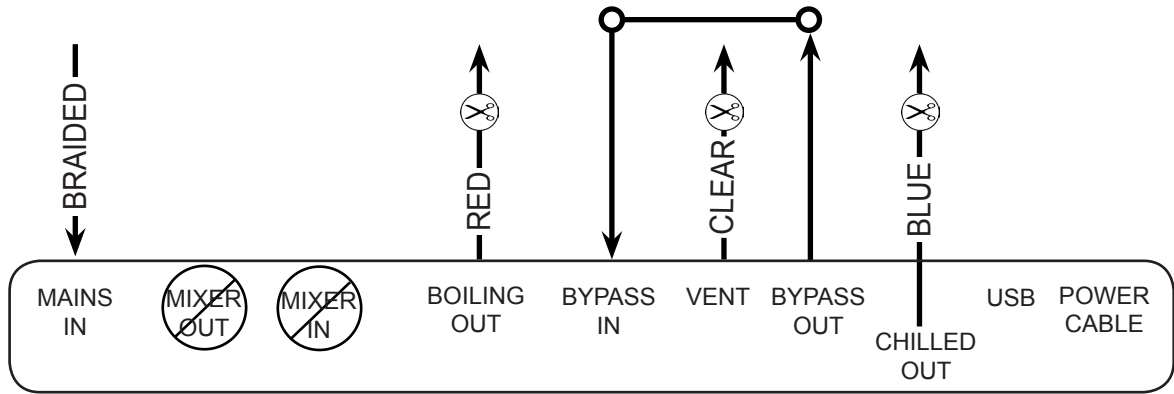

Note All silicon tubes / plastic pipes must be cut to size. They must have a constant fall back to the Command-Centre™

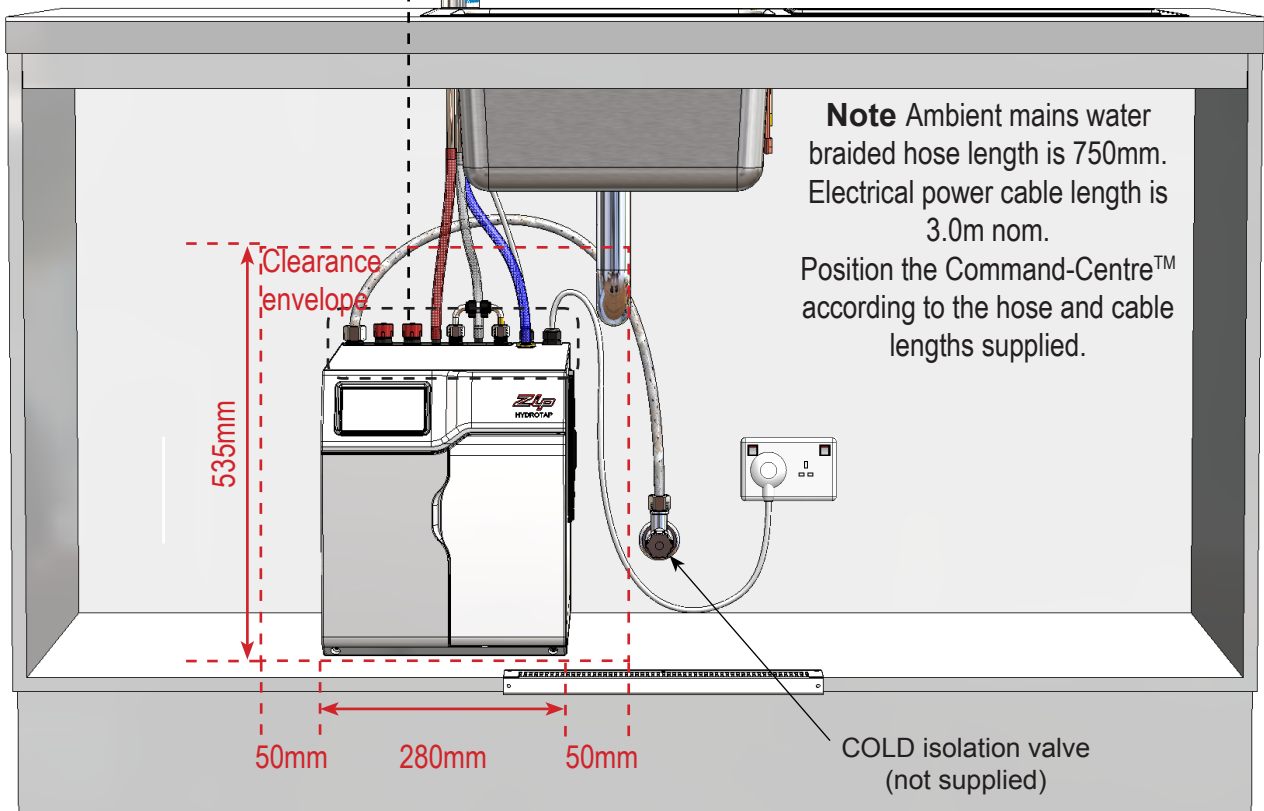

Note The braided hoses and connection tubes supplied with the tap head assembly and cold inlet CANNOT be lengthened.

⊘ Not required for standard BC models.

Installation instructions

4.4 HydroTap®G4 and mixer tap combinations Refer to 803341UK Tap installation instructions (for Arc / Cube also refer to the tube kit assembly instructions) supplied with the tap.

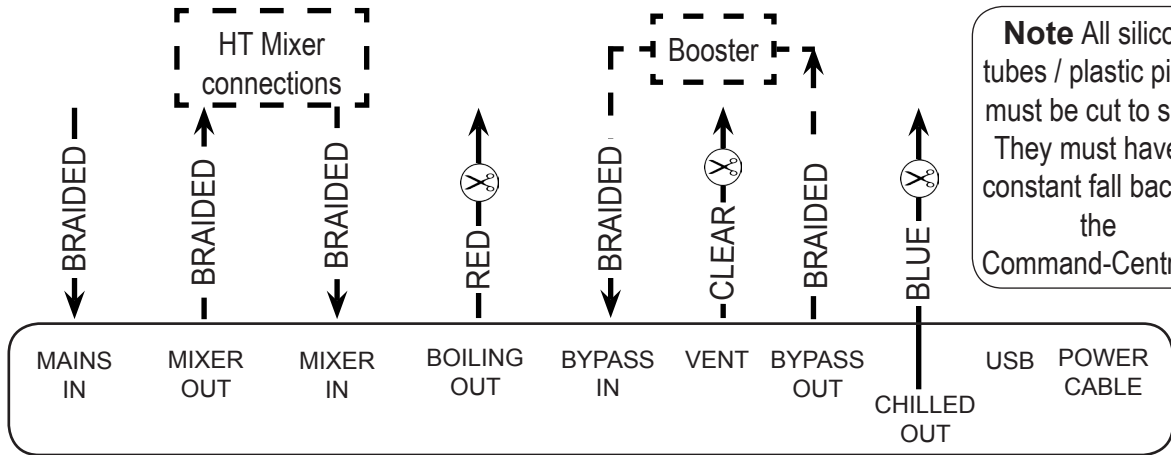
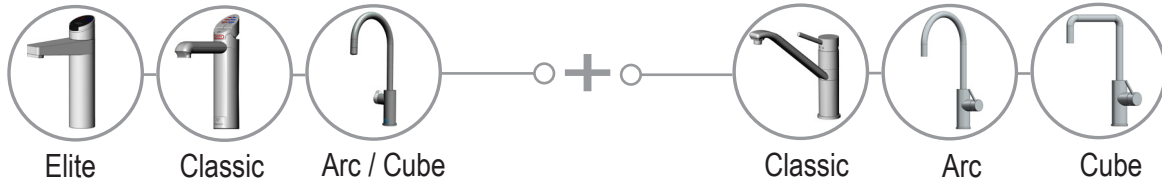

Note All silicon tubes / plastic pipes must be cut to size. They must have a constant fall back to the Command-Centre™

Note Ambient mains water braided hose length is 750mm. Electrical power cable length is 3.0m nom. Position the Command-Centre™ according to the hose and cable lengths supplied.

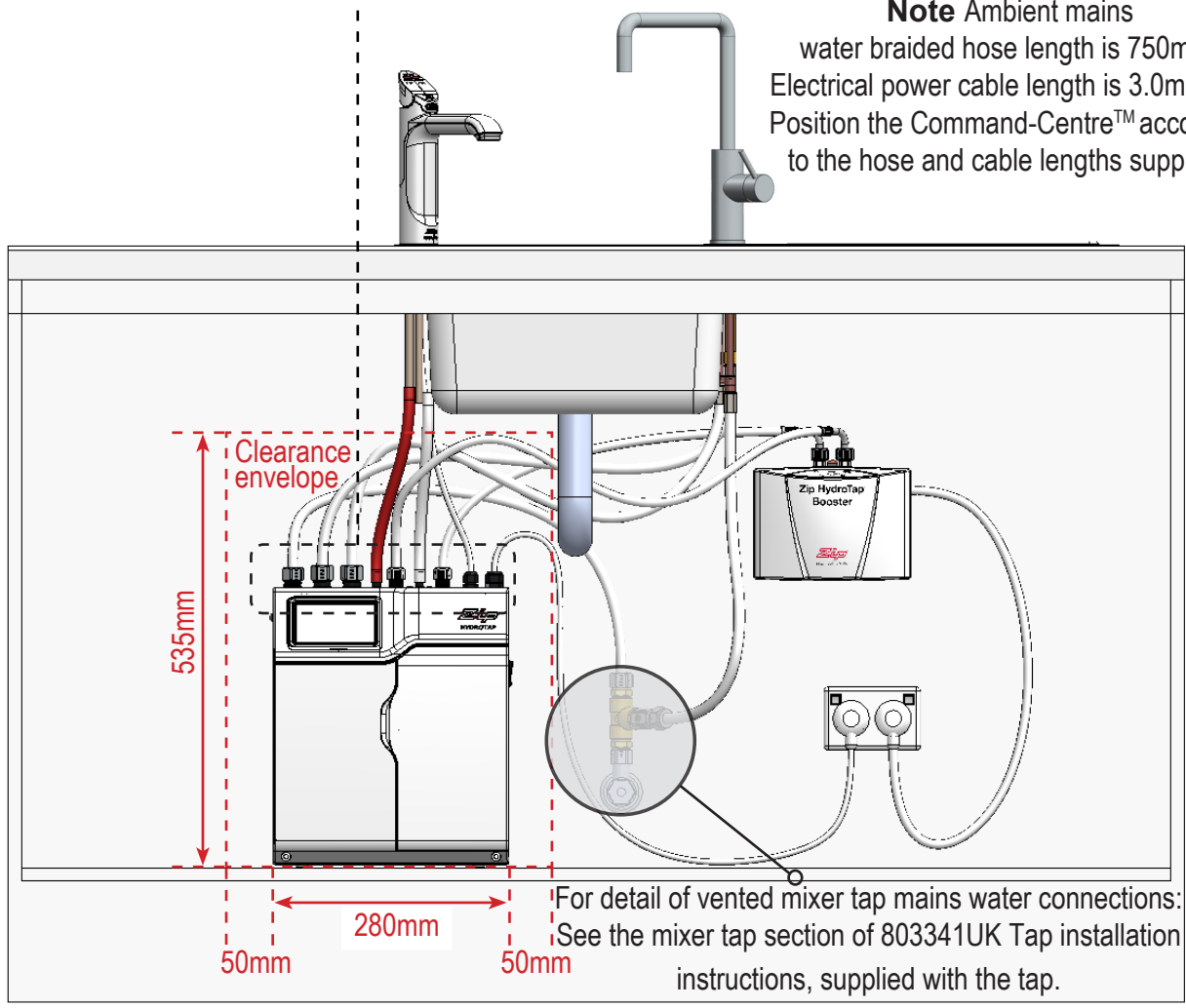

Note The braided hose and connection tubes supplied with the HydroTap®G4 inc. cold inlet and booster CANNOT be lengthened.

Installation instructions

4.5 All-in-One 'Mains' tap Refer to 803341UK Tap installation instructions (for Arc / Cube also refer to the tube kit assembly instructions) supplied with the tap.

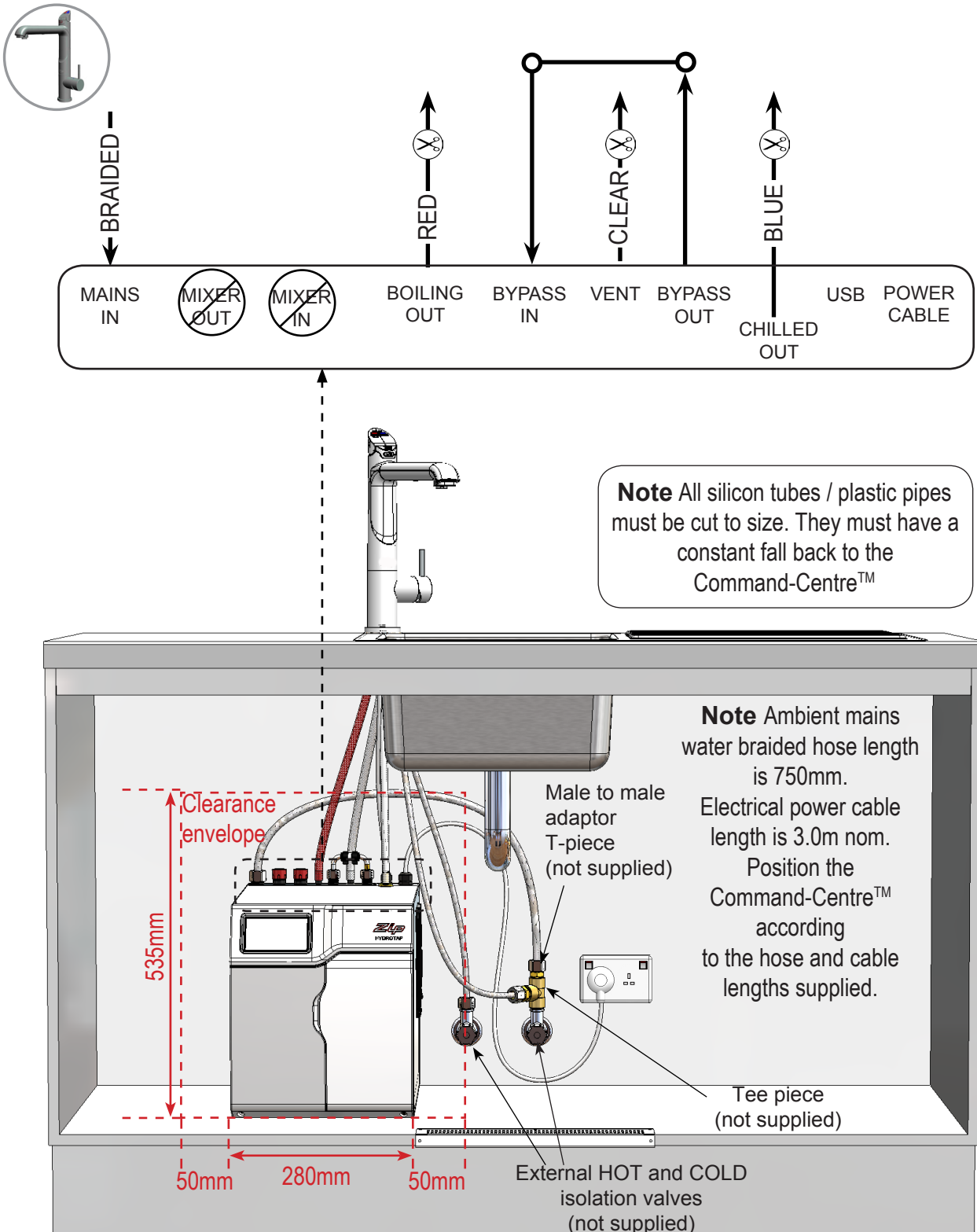

Note The braided hoses and connection tubes supplied with the HydroTap®G4 inc. cold inlet CANNOT be lengthened.

⊘ Not required for AIO mains pressure HydroTap®G4.

Installation instructions

4.6 All-in-One 'Vented' tap Refer to 803341UK Tap installation instructions (for Arc / Cube also refer to the tube kit assembly instructions) supplied with the tap.

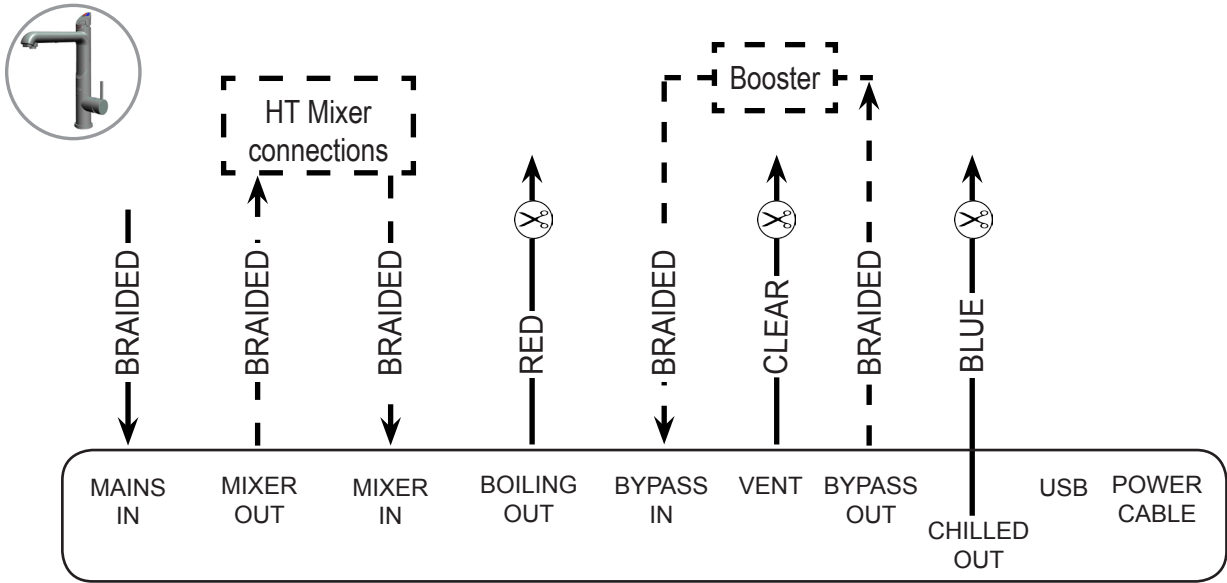

Note All silicon tubes / plastic pipes must be cut to size. They must have a constant fall back to the Command-Centre™

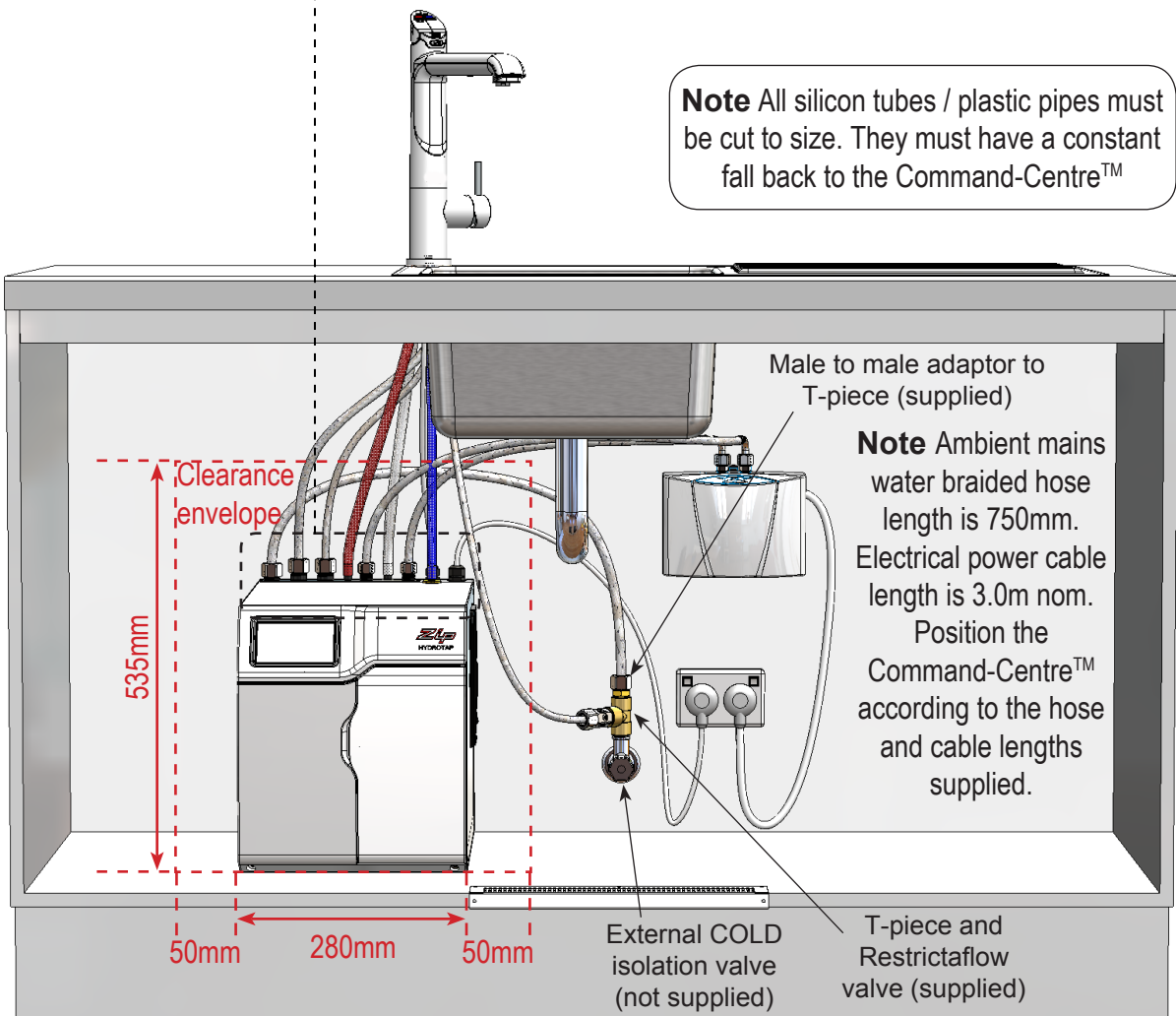

Note Ambient mains water braided hose length is 750mm. Electrical power cable length is 3.0m nom. Position the Command-Centre™ according to the hose and cable lengths supplied.

Note The braided hoses and connection tubes supplied with the HydroTap®G4 inc. cold inlet and booster CANNOT be lengthened.

Section 5 Commissioning

The HydroTap®G4 is now ready to be commissioned.

- Turn the power and water on and check for any leaks.
- If fitted, ensure the booster is turned off. (The booster is commissioned later, see page 22).
- Familiarise yourself with the operation of the tap, in preparation for use, see the user manual.
- Follow the installation instructions below (and read section C of the user manual).
- After commissioning, the system may be customised by selecting further options in section G - settings of the user manual.

5.1 Select the language

Initial commissioning screen

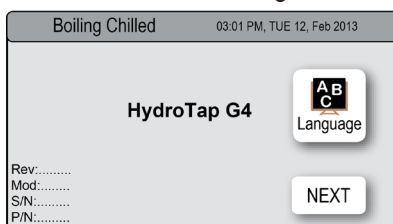

Language selection screen

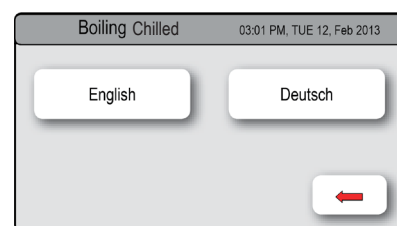

5.2 Filter flush

Have a bucket or similar container (not supplied) at the ready to hold a quantity of water that will be ejected while the filter flush mode is in operation. Open the filter access door on the front of the HydroTap®G4 and the filter cartridge will be exposed. Located to the rear right hand side of the cartridge is a flush line, approx 600mm long and the flush line stop cock. Place the free end of the flush line into the bucket or container (not supplied). **Note** At first commissioning, the system will select the filter flush screen automatically.

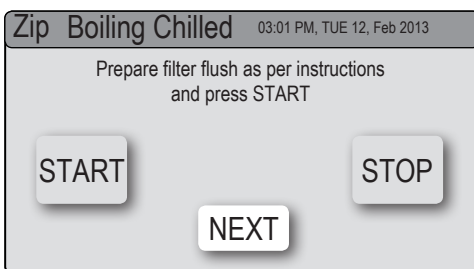
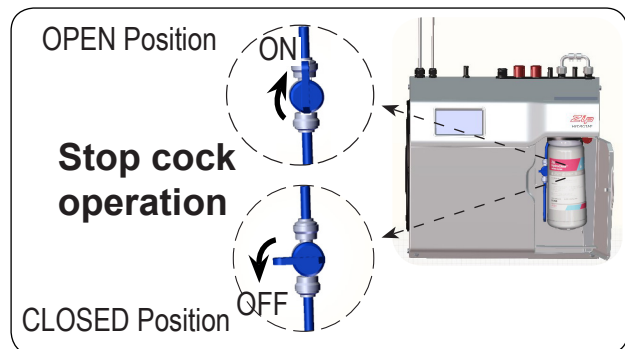

- Press [START] / [STOP] button to start and stop the filter flush.
- Turn the flush stop cock on.
- Allow at least 10 litres of water to flush through the filter.
- Once the filter flush is finished, Turn the stop cock off then press [STOP] to end filter flush mode.
- Press [NEXT] for the flow calibration screen
- Press the [START] button and the tank will first empty then fill. Upon completion the pulse count will be displayed. Check the value is within limits.
- Press [NEXT] for the boiling calibration screen.

5.3 Flow calibration

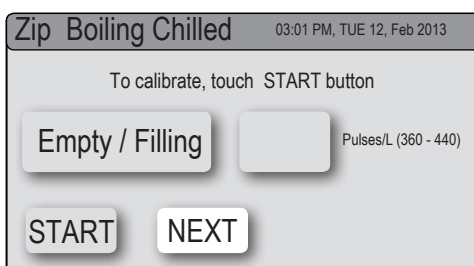

Note For any subsequent filter changes or any operational procedures, please refer to the HydroTap®G4 user manual, located inside the filter housing access door.

Commissioning

5.4 Boiling calibration (boiling models)

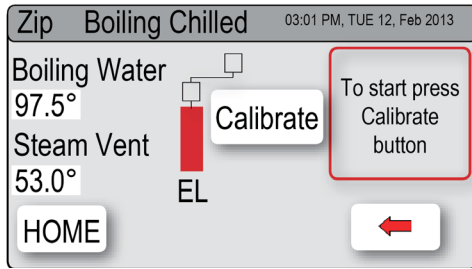

- Press the [Calibrate] button and the system will start the boiling calibration procedure. This will take approx. 5 to 6 minutes.

5.5 To enable a booster, when installed.

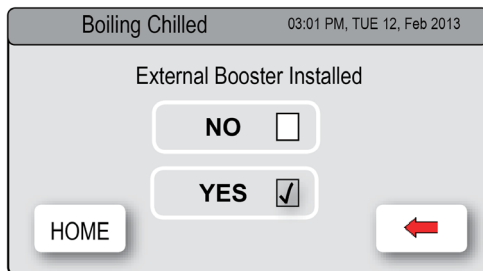

- Press the [MENU] button for main menu.
- Press the [Install] button.
- Press the [Boost] button.
- In the next screen, select [YES] to enable the booster.
- Before connecting the power to the booster, water must be run through for a min. of 30 seconds to purge. Run the boiling tap for 30 seconds and the allow the tank to refill.
- Dispense boiling water for 30 seconds and check the booster outlet hose is warm when the boiling water tank is replenishing.

Note Failing to make the correct selection for the booster will affect performance.

Note Depending on your location you may need to reset the internal clock. See section G of the user manual to reset the date and time.

5.6 Safety sensor calibration (Classic models)

Light intensity varies from site to site, therefore it is recommended that a re-calibration be performed at the time of the installation.

All direct sunlight must be shaded from the HydroTap®G4, during the calibration. This can be achieved by closing any nearby curtains, blinds, etc.

Procedure

- Shield the HydroTap®G4 from direct sunlight.
- In normal operating mode. Turn the power off.
- Pull both tap levers to the forward position.
- Turn the power on.
- The safety sensor will calibrate.
- Return the levers to the neutral position.

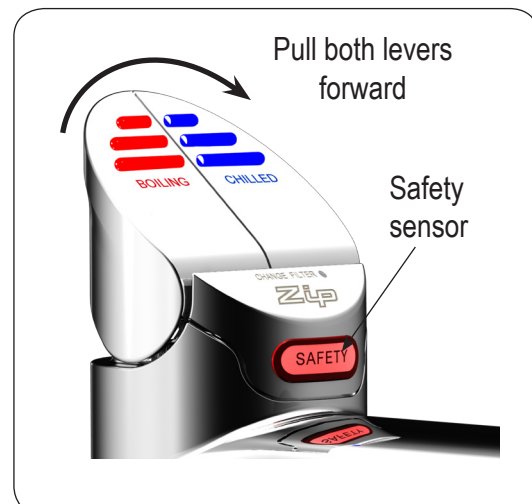

Trouble shooting

| System fault message | Possible cause | Solutions |
|----------------------------|-----------------------|---|
| Power Board Fault | Electrical disruption | Check power supply and all fuses |
| Interface Fault | Internal fault | Call Zip Service |
| Level Board Fault | Internal fault | Call Zip Service |
| Condenser Screen Blocked | Blocked air filter | Remove blockage / clean filter / check user guide |
| Water leak, Isolate Mains | Water leak | Turn off mains water supply / call for service |
| Compressor Over Run | Compressor too hot | Check ventilation |
| Water Supply Failure | No water | Check water supply is turned ON |
| Hot Sensor Open | Internal fault | Call Zip Service |
| Hot Sensor Closed | Internal fault | Call Zip Service |
| Cold Sensor Open | Internal fault | Call Zip Service |
| Cold Sensor Closed | Internal fault | Call Zip Service |
| Flood Sensor Open | Internal fault | Call Zip Service |
| Condenser Sensor Closed | Internal fault | Check ventilation / call Zip Service |
| Condenser Sensor Open | Internal fault | Check ventilation / call Zip service |
| Heater Fuse / Driver Fault | Internal fault | Call Zip Service |
| Heater Driver Fault | No hot water | Call Zip Service |
| Compressor Driver Fault | No chilled water | Call Zip Service |
| Hot Sensor Degraded | Internal fault | Call Zip Service |
| Condenser Overtemp | Blocked air filter | Remove blockage / clean filter / check user guide |
| A DC Pump is faulty | Internal fault | Call Zip Service |
| Steam too Cool | Internal fault | Call Zip Service |
| Steam Sensor Open | Internal fault | Call Zip Service |
| Steam Sensor Closed | Internal fault | Call Zip Service |
| Hot Tank Over filled | Internal fault | Call Zip Service |
| Comp Fuse/Driver Fault | Internal fault | Call Zip Service |
| Hot Tank Under filled | Low water pressure | Check water supply |
| Boil Dry Protection | Safety activated | Turn OFF/ON power to reset |
| Flash Memory corrupted | Internal fault | Call Zip Service |
| Flow Sensor Fault | Internal fault | Call Zip Service |

Call an electrician, a plumber, or Zip on 0345 6 005 005 for assistance, service, spare parts or enquiries.

End of life disposal



The use of this crossed out wheeled bin logo indicates that this product needs to be disposed of separately to any other household waste.

Within each of the European Union member countries, provisions have been made for collection and recycling of unwanted electrical and electronic equipment. In order to help preserve our environment we ask that you dispose of this product correctly. Please contact Zip Customer Service on 0345 6 005 005 for advice.

Warranty

Certain warranties may be implied by law into your contract with Zip. The warranty provided below is additional to these implied warranties and nothing set out below shall limit your statutory rights or rights at law. Zip Heaters (UK) warrants that, should the hot tank fail within five years of installation subject to satisfactory maintenance and registration of the product, or any part fail within three years of installation, the part will be repaired or replaced free of charge by Zip, its distributor or service provider, (except as set out below), provided the appliance is installed and used strictly in accordance with the instructions supplied, and that failure is not due to accident, misuse, abuse, unsuitable water conditions, or to any alteration, modification or repair by any party not expressly nominated by Zip.

No costs are payable by the customer other than any mileage or travelling-time charges incurred by a Zip service provider or the cost of removal, cartage and re-installation of any component of the appliance if it needs to be returned for repair to Zip or its distributor.

This warranty does not cover damage resulting from non-operation of the appliance, the use of non authorised parts or consequential damage to any other goods, furnishings or property.

No warranty applies to the life of any filtration cartridge installed with the appliance as cartridge life may vary according to water quality and the rate of water consumption.

Zip does not exclude, restrict or modify any liability that cannot be excluded, restricted or modified or which cannot, except to a limited extent, be excluded, restricted or modified as between the owner or user and Zip under the laws applicable.

Furthermore this warranty does not displace any statutory warranty, but, to the extent to which Zip is entitled to do so, the liability of Zip under any statutory warranty will be limited at Zip's option to the replacement of the appliance or supply of equivalent appliance, the payment of the cost of replacing the appliance or acquiring an equivalent appliance, or the payment of the cost of having the appliance repaired or the repair of the appliance.

HydroTap®G4 residential models are designed specifically for use in a domestic environment and inappropriate installations such as in a commercial location will invalidate the warranty.

Registering your purchase.

Registering your Zip installation on the Zip website may help to establish date of installation should it become necessary to service the appliance under terms of the Zip warranty. To register your installation go to www.zipwater.com/uk and look under the heading "Warranty".

Contact Details

Zip Water UK
14 Bertie Ward Way
Dereham
Norfolk
NR19 1TE

Website: www.zipwater.com/uk
Email: sales@zipindustries.co.uk
Facsimile: 01362 692 448
Telephone: 0345 6 005 005



Zip[®]
Instant Boiling Water

The standard cup referred to in this publication is 167 ml (6 fl oz).

The standard glass is 200 ml (7 fl oz).

The terms "Zip" and "HydroTap" are registered trade marks of Zip Heaters (Aust) Pty Ltd.

Zip products described in this publication are manufactured under one or more of the following patents: AU675601, AU637412, AU635979, GB0422305, GB2065848, US4354049, US5103859, US5099825 and SA2006/08043. Other patents are in force and patent applications are pending.