

# Gorillo Pro Blade Hand Dryer User Manual







**handy**dryers





[www.handydryers.co.uk](http://www.handydryers.co.uk)

01279 466 500

	<h2 style="text-align: center;">Contents</h2> <p><b>Warning .....2</b></p> <p><b>Features.....3</b></p> <p><b>Part names.....4</b></p> <p><b>Specification.....4</b></p> <p><b>Installation procedures.....5</b></p> <p><b>Routine cleaning .....9</b></p> <p><b>Using the unit.....10</b></p> <p><b>Troubleshooting.....10</b></p>
---	---

 <p><b>Warning :</b></p>	<p>This product should only be used as instructed and fitted by a professional electrician to avoid injury or machine failure.</p>
---	--

 <p>prohibited</p>	<p><b>Don't open the front panel whilst electric is turned on.</b> This may result in the user being at risk of an electric shock.</p>
 <p>don't use in the bathtub or shower room</p>	<p><b>Do not use in a wet environment, for example, in a washroom where it may get directly splashed with water or in places where excess condensation may form</b> This may result in the user receiving an electric shock or cause the unit to malfunction.</p>
 <p>prohibit disassembling</p>	<p><b>Do not modify and disassemble the unit unnecessarily</b> Otherwise this may cause a fire, electric shock or personal injury.</p>

 <p>Important! Always follow instructions closely</p>	<p><b>Use a single-phase AC 220~240V/50/60Hz power supply</b></p> <p><b>Use within the required voltage, as voltage exceeding 220V +10% will fail the unit</b> Using an incorrect power supply may cause fire, electric shock and malfunction.</p> <p><b>Use separate line</b> Using any other electric appliance with the same line, may cause the branch socket to become very hot and cause fire.</p> <p><b>Turn off the power switch before inspecting and cleaning the unit</b> Otherwise, may cause electric shock.</p>
 <p>earth grounding connection</p>	<p><b>Ensure the unit is properly grounded</b> Otherwise this may cause electric shock during malfunction or a short circuit.</p> <p><b>Installation work should be done by the qualified technician.</b> Incorrect wiring connection can cause electric shock and fire</p> <p><b>Be sure to install a residual current circuit breaker</b> Otherwise, this may cause electric shock</p> <p><b>Use a type whose contact points are at least 3mm apart</b> Please use the product of CCC standard. Recommended residual current circuit breaker (for ground-fault protection). (use a single-phase 2-line, AC 220 ~ 240V/50/60Hz cable with a 20A rated current, 15mA-type rated operating current)</p>
 <p>Prohibited</p>	<p><b>Do not let children hang from the unit.</b></p>  <p>Otherwise, this may cause the unit to drop.</p>
 <p>Important! Follow instructions</p>	<p><b>Always use the unit with the drain tank and air filter attached</b> Once water enters the unit inside, short circuit or electric shock occurs.</p> <p><b>Wear gloves when inspecting and cleaning the unit</b> Otherwise, this may cause injury</p> <p><b>If the unit does not start or works abnormally, turn off the power switch and ground fault breaker and contact your dealer for inspection and repair.</b> Otherwise, this may cause electric shock or fire due to short circuit</p>

**Do not use in the following places:**

Where the unit may come into direct contact with water

Where the unit is under direct or strong sunlight(this may cause sensor to malfunction)

Where the condensation may form within the unit

**Safety precautions before installing the unit**

.Do not attempt to install the unit with the power on(power cord)

Otherwise, this may cause electric shock

.The installation location should be strong enough to support the unit ,and the unit should be installed firmly on the surface

Otherwise ,this may cause personal injury due to the unit falling

.Wear gloves when installing the unit

Otherwise ,this may cause injury

**Features:**

“No touch” hand drying ensures complete hygiene.

High-speed motors with optional heater allows for economical use.

A tamper-proof timer built is to prevent overuse.

To prevent overusing the unit, the built-in timer will stop the unit after 30 seconds. To continue use, draw back your hands and put them in again.

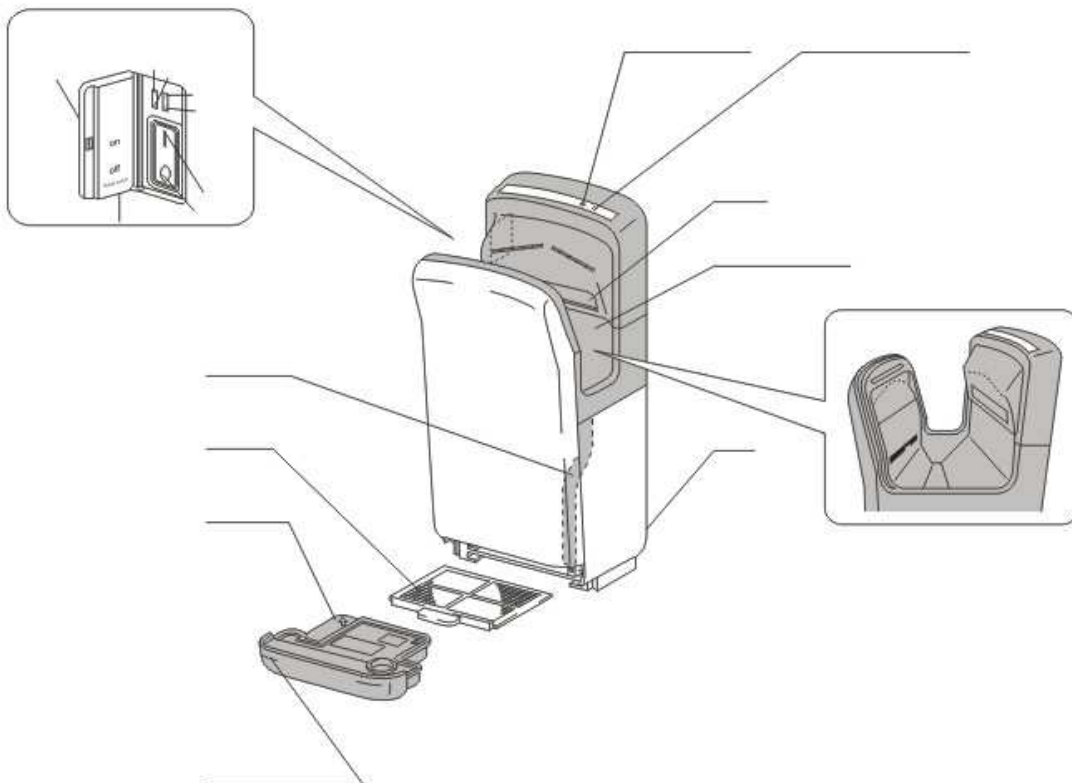

**Before starting to operate the Gorillo hand dryer:**

Turn on the power switch (located in the lower part of the side switch)

The power indicator light on the top of the hand dryer should light up  
The LED lights in U-shaped sink light up.

PTC heater control

There are 2 switches in upper part of the switch.

On the right, choose to turn on “Hot” and the heater will heat the air.

On the right, choose to turn on “Cool”, and the heater will be turned off for economical use.

If you choose to turn the heater on you have two heating options.

1. Turn the left switch into “Auto heating” and the heater will be used when the ambient air temperature is below a threshold monitored by the included microcomputer.

(Usually the heater is operated by computer when the ambient temperature is less than 25 °C)

2. Turn the left switch into “All time heating”, the heater will always be used to heat the air from the hand dryer.

**Specification:**

Rated Voltage	<input type="checkbox"/> AC220-240v <input type="checkbox"/> AC110-127V	Waterproof Grade	IPX4
Rated Frequency	50/60HZ	Air speed	90m/s
Rated Power	800W + (PTC 1100W)	Drying Time	5-7S
Motor Power	800W	Overall size(mm)	300*220*687mm

## Installation Procedures:

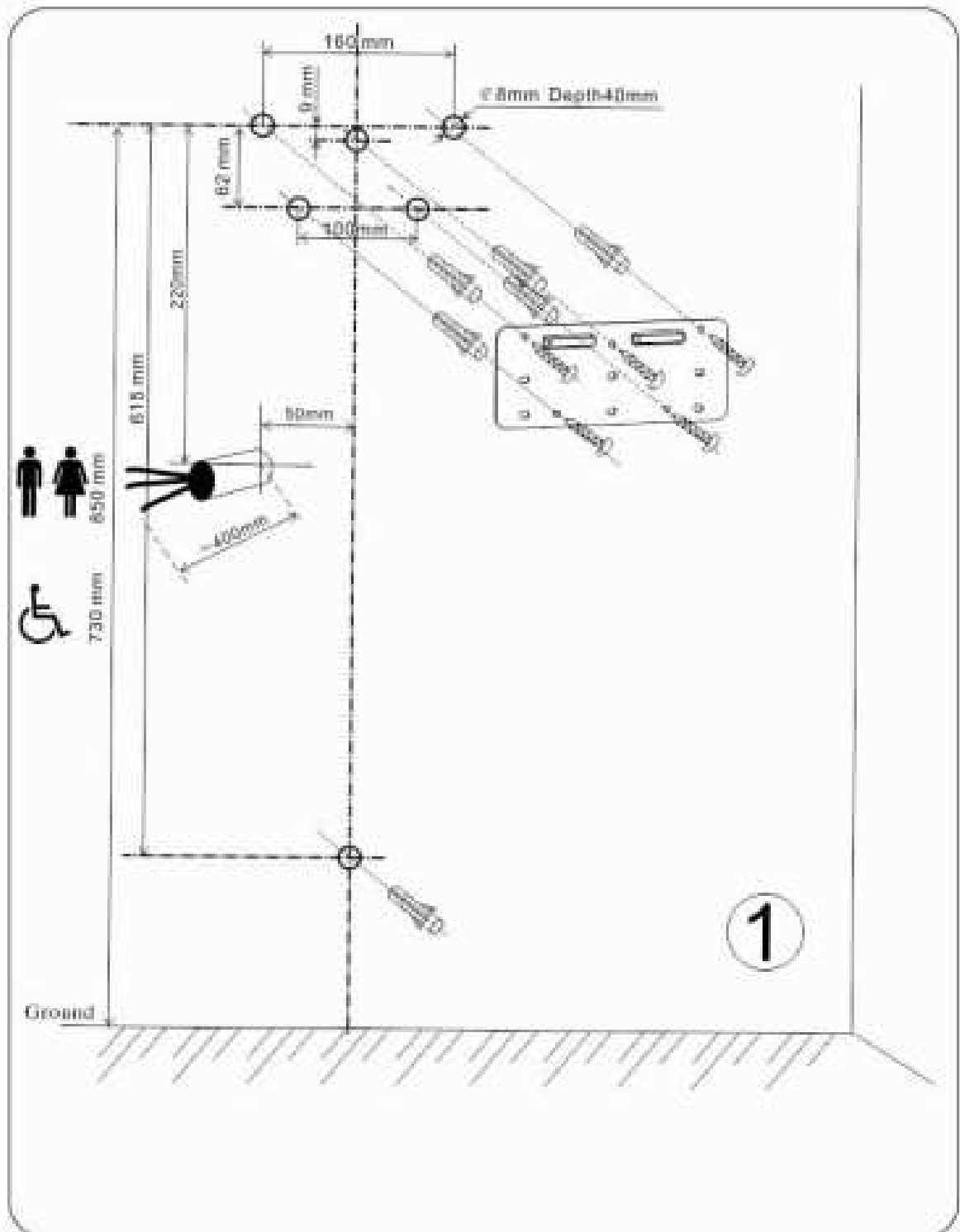

## Installation Procedures:



2

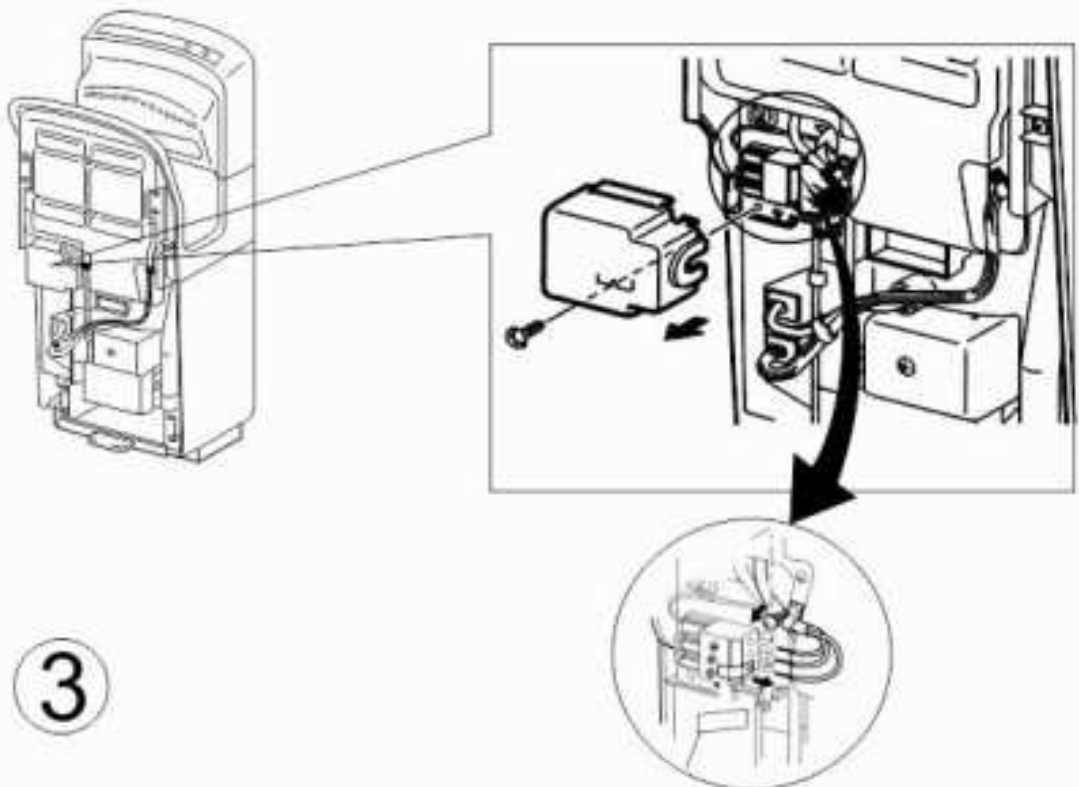

3

## Installation Procedures:

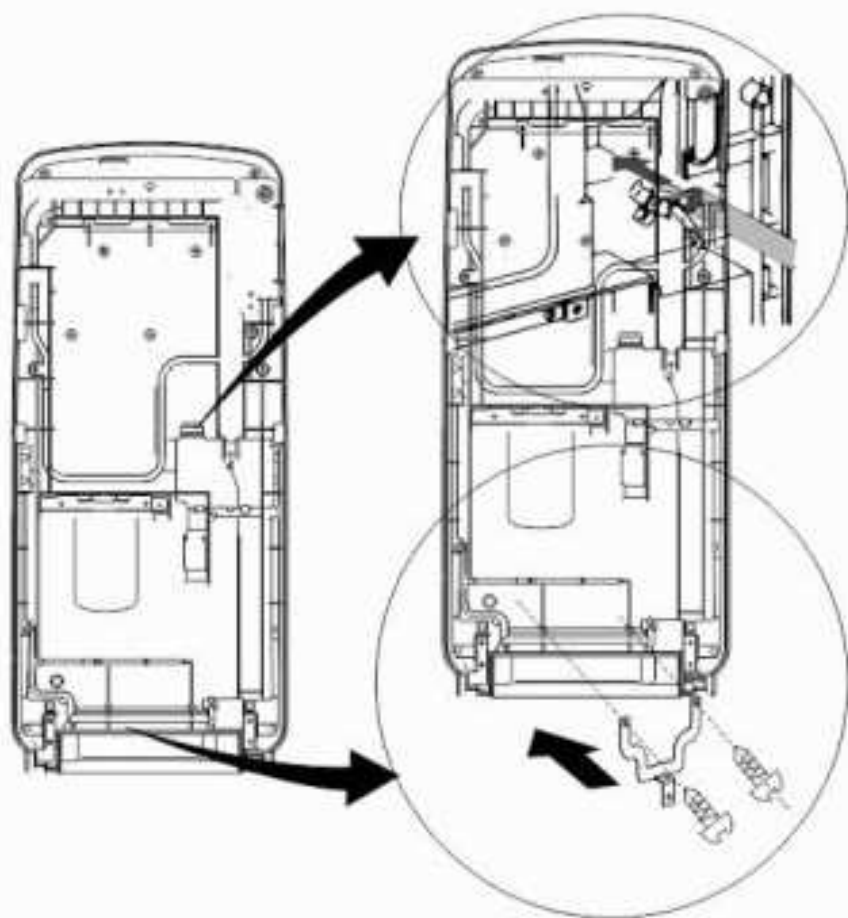

4

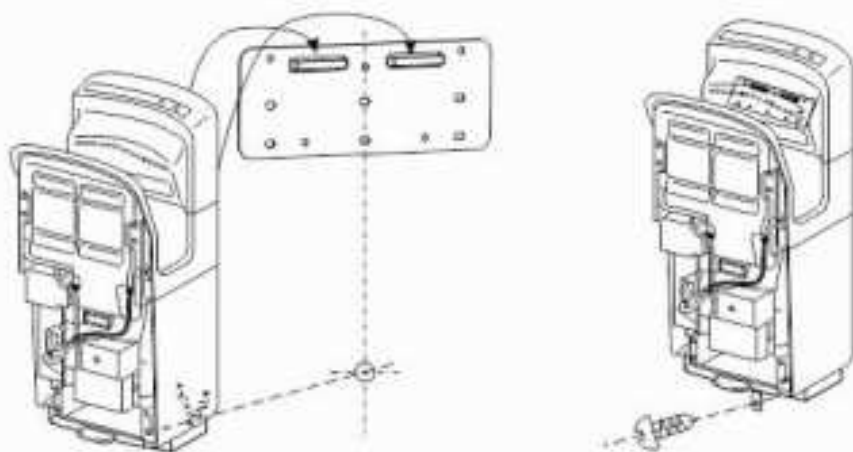

5



Cleaning your Gorillo hand dryer

You can clean the Gorillo hand dryer with a soft cloth.

If the unit gets very dirty we recommend you clean with a soft cloth dampened with neutral agent, then clean with a dry soft cloth.

Ensure you remove the dirt from the sensor (to prevent malfunction)

 <p>Note</p>	<p>Only use the neutral cleaning agent. Do not use thinner, acidic or alkaline toilet cleaners, or a nylon brush. (Otherwise, they may damage the smoothness of surface) Only use the alcohol to clean the hand-drying area. (Do not use alcohol anywhere else) Alcohol here means the alcohol used for disinfection (concentration below 83%) If the chemical cloths used, please read their instructions first. Disinfecting agents will damage your unit.</p>
---	--



Warning: Before you clean the unit ensure you turn off the power switch.



Caution: Wear gloves when cleaning.



**Draining and cleaning the drain tank before it fills up (at least once a week)**

The water blown off the hands is called “drain water”

Empty the drain water when needed in order to prevent accumulated water from exceeding the full level.

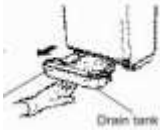
The water risks stagnation if not removed regularly.

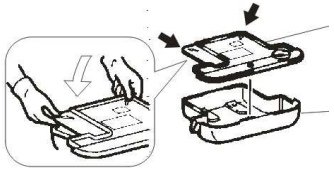
<p>1</p>	<p>Pull the drain tank out in the horizontal direction. This ensures the drain water does not spill out.</p>	
<p>2</p>	<p>1. Open the cover and empty the water. Pull the cover up with your fingers in the direction of the arrow on top of the cover, and then remove the cover completely. 2. Wash out the interior of the drainage tank.</p>	<p>Cover</p>

	<p>3. Close the water tank cover and re-attach it to the unit. Confirm the two locations are firmly inserted.</p>	
<p>3</p>	<p>Add 200cc (around 1 cup) of water through the drain hole. (to prevent it from getting clogged)</p> <p>Use the unit after confirming that the water tank is in place.</p>	

**Clean the HEPA air filter once a week.**

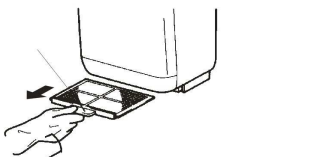
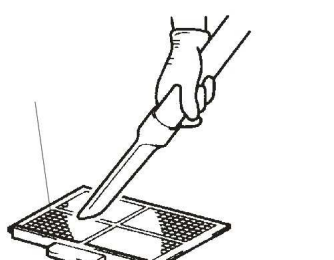
<p>1</p>	<p>To remove the air filter simply pull the air filter out by the handle.</p>	
<p>2</p>	<p>1. To clean the air filter beat it lightly by hand or use a vacuum cleaner. If it is very dirty, wash it off with cold or warm water. 2. Re-attach to the unit 3. Push the air filter all the way in, until it stops. If the unit is not replaced correctly the dirt and dust will filter in to the machine and reduce the service life.</p>	

 <p>Note</p>	<p>If you wash the air filter with water dry it as much as possible before replacing. Do not expose to the fire</p>
---	---

## Troubleshooting

If the following problems occur, please perform checks to see if problem is fixed.

Error	Check	Action
No air blows even if hands are inserted.	Do the display indicators lights up? Is the power switch on? Are you putting your hands all the way in?	Turn the ground-fault circuit breaker on. Turn the power switch on Put hands all the way in
The unit does not stop blowing.	Is the sensor blocked by the dirt or dust?	Turn the power switch off, and then, after all the lamps in the display have gone off, remove the dust matter.
No hot air comes out.	Is the heater turned on, is the heater sensor dirty?	Turn the power switch off, check all the indicators in the display area have gone off (around 40 seconds) then turn on the power switch again.
If the above actions do not work, turn off the power and the ground -fault circuit breaker, and call your dealer to inspect and repair it if necessary.		

**handy**dryers