

Streamline

Vented point of use hot water





Streamline

Quick access to hot water can be a serious health and safety issue or a simple matter of comfort.

It all depends on where, or for what, it's needed. However, distance from a suitable hot water store or the complete lack of a store can mean that hot water often isn't available.

Streamline vented water heaters are our straightforward solution. They provide a single output of reliable hot water for home or work applications. There are eight models to choose from covering both undersink and oversink use – with 13 taps, spouts and mixers to meet virtually every conceivable need. Streamline only requires a cold water supply and mains electricity. They're quick to fit, easy to use and can be adapted to suit all sorts of requirements.

Each Streamline water heater is backed by a two year guarantee with on-site service support.

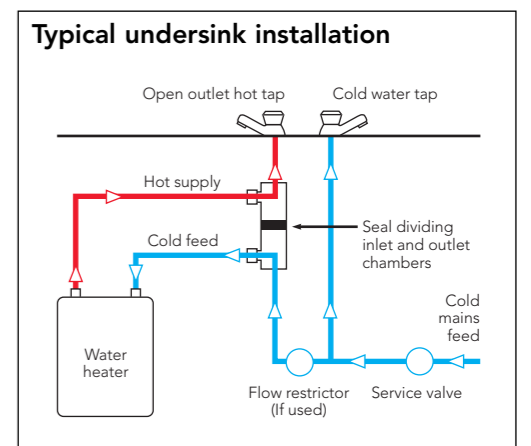
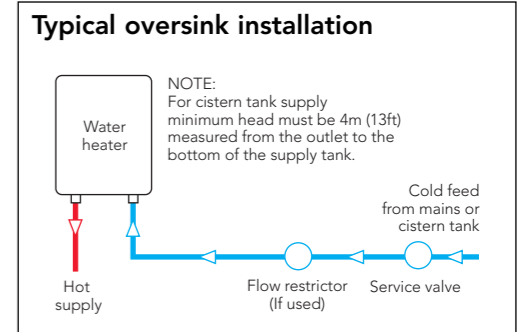

Streamline

An attractive, thermoplastic, point of use product offering remarkable versatility, Streamline comes in two sizes, each with two ratings. It is available as a complete oversink unit with a thermoplastic spout and valve or as a heater only.

The heater only version can be converted for undersink use in conjunction with Heatrae Sadia's open outlet taps.

- Choice of 7 or 10 litre capacities.
- White case with grey spout and flow control.
- Compact, low profile.
- 1kW or 3kW rating.
- Choice of 13 vented taps, spouts and mixers.
- Easy conversion from oversink to undersink use.
- Easy access for maintenance.
- Externally adjustable thermostat from 5°C to 90°C.
- 40°C temperature lock for hand-wash applications.
- Dry start cut-out.
- Anti-frost protection.
- Long-life alloy sheathed element.
- Two year guarantee with on-site service support.



Oversink taps and accessories (For use with Streamline only)

Streamline 1000[†]

A standard monobloc mixer tap.

Streamline 2000[†]

A monobloc mixer tap with pop-up waste fitting (pop-up waste fitting suitable for ceramic sinks only).

Streamline 2000 elbow lever[†]

A monobloc mixer tap with elbow lever and pop-up waste fitting, ideal for surgical / medical environments (pop-up waste fitting suitable for ceramic sinks only).

Pack B Standard spout and valve.

Pack C Telescopic spout (380-610mm) valve.

Pack Z – Streamline undersink only[‡]

Splash guard with two connectors. Enables existing vented taps to be used when a new Streamline unit replaces an earlier Heatrae Sadia undersink water heater.

Undersink taps and accessories (For use with Streamline, Express and UTC 99)

Pack J[†]

Two-hole mixer tap. Chrome plated and elegantly styled.

Pack K[†]

Monobloc mixer tap. A graceful design, ideal for the modern kitchen.

Pack M[†]

Elbow pillar tap. 1/4 turn lever, ideal for surgical / medical environments (hot and cold taps supplied).

Pack P[†]

Elbow basin tap. 1/4 turn lever, ideal for surgical / medical environments (hot and cold taps supplied).

Pack Q[†]

Two-hole elbow mixer tap. 1/4 turn levers, ideal for surgical / medical environments.

Pack R[†]

Pillar tap (hot and cold taps supplied).

Pack S[†]

Basin hot tap.

Pack T[†]

Basin cold tap (cold tap only to match Pack S).

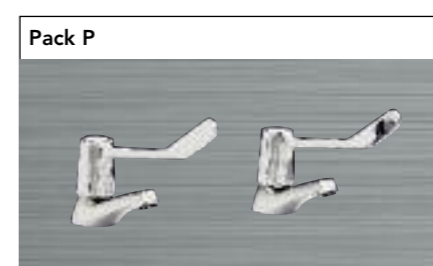
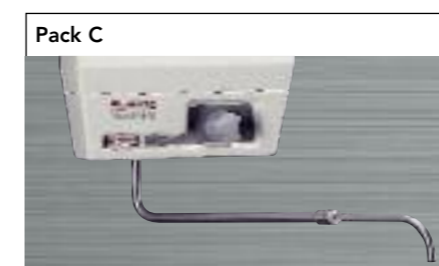
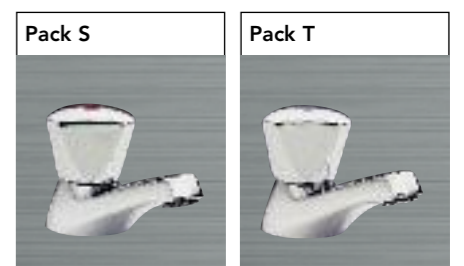
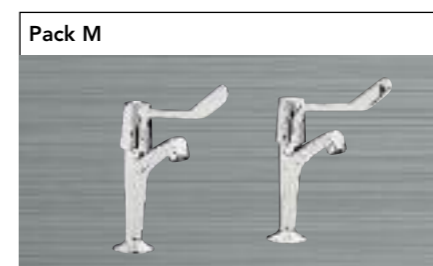
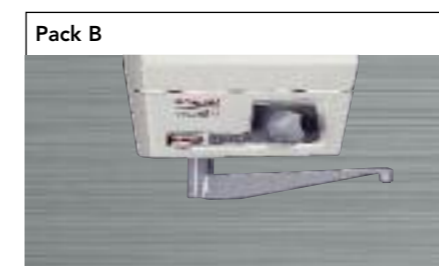
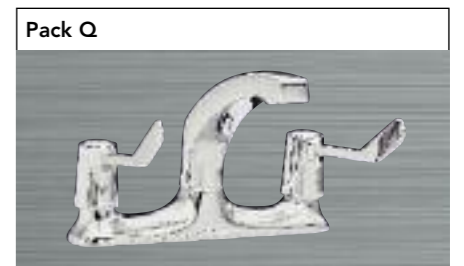
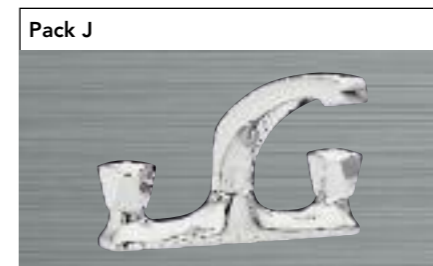
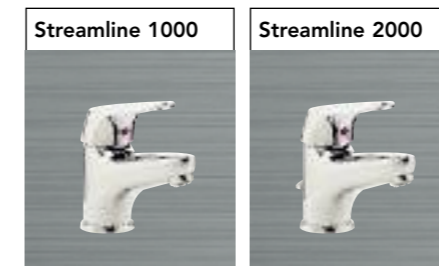

* IMPORTANT: Streamline 1000 / 2000 for sinks and basins with 37 to 39mm tap holes.

† Product appearance may vary slightly from that shown. Performance and function will remain the same.

‡ The splash guard and connectors are included in all vented tap packs.

Accessory dimensions and ordering

Streamline 1000

Streamline 2000

Streamline 2000 elbow lever

Pack J

Pack K

Pack M

Pack P

Pack Q

Pack R

Pack S

Pack T

Connections for Packs J, M, P, Q, R and S

Model	Product code
Streamline 1000*†	95:970:344
Streamline 2000*†	95:970:345
Streamline 2000 with elbow lever*†	95:970:346
Pack B	95:970:327
Pack C	95:970:329
Pack Z	95:970:319

Model	Product code
Pack J†	95:970:295
Pack K†	95:970:296
Pack M†	95:970:298
Pack P†	95:970:299
Pack Q†	95:970:310
Pack R†	95:970:311
Pack S†	95:970:312
Pack T†	95:970:313

* IMPORTANT: Streamline 1000 / 2000 for sinks and basins with 37 to 39mm tap holes.
 † Product appearance may vary slightly from that shown. Performance and function will remain the same.

Full specification, dimensions and ordering

Specification

Capacities
7 and 10 litre.

Rating
1kW, 3kW @ 240V, (0.9kW, 2.8kW @ 230V).

Outer casing
White moulded thermoplastic.

Thermal insulation
CFC / HCFC free (ODP zero) flame-retardant expanded polystyrene.

Water container
Polypropylene, tested to 0.5 bar (7psi).

Heat unit
Rod-type alloy sheathed element.

Thermostat
Capillary-type, externally adjustable from 5°C to 90°C.

Safety features
Dry start cut-out. Frost protection thermostat setting. Thermostat setting lockable at 40°C for hand washing.

Approvals
BEAB and kiwa approved to UK Water Supply Regulations. CE marked. Manufactured in the UK in a BS EN ISO 9001:2000 registered factory.

Installation

Fixing
Bracket, screws and plugs supplied for wall-mounting. For undersink use, the basic unit is inverted after the heating element has been rotated.

Plumbing
All installations should be fitted with a service valve to facilitate maintenance (not supplied). Minimum inlet pressure should be 0.34 bar (5psi) at which maximum flow is 5 litres/min. A flow restrictor (available as an accessory) should be fitted for inlet pressures above 0.69 bar (10psi) to limit flow to 7 litres/min.

Supply direct from rising main or cistern (minimum head 4m) using 15mm O/D pipe. Cistern supply is not possible for all outlet types; consult Heatrae Sadia for further advice.

NOTE: Only Heatrae Sadia vented taps must be used with Streamline heaters.

Electrical
Cable entry at rear or base of unit for oversink installations and at rear or top for undersink installations. Must be permanently connected to the electrical supply through a double-pole linked isolating switch with a minimum rating of 13A (3kW model) or 5A (1kW model).

Must conform to current IEE wiring regulations.

Guarantee

Streamline carries a full two year transferable on-site service support guarantee against faulty manufacture or materials provided that:

- It has been correctly installed as per the instructions contained in the instruction manual and all relevant Codes of Practice and Regulations in force at the time of installation.
- It has been installed in the UK.
- It has not been modified in any way, other than by Heatrae Sadia Heating.
- The damage is not due to scaling or frost.
- It has only been used for the storage of potable water.
- It has not been tampered with or been subjected to misuse or neglect.
- Within 60 days of installation the user completes and returns the certificate supplied along with the proof of purchase to register the product.

Evidence of purchase and date of supply must be submitted. The unit is not guaranteed against damage due to frost. The guarantee is transferable. This guarantee does not affect your statutory rights.

Dimensions

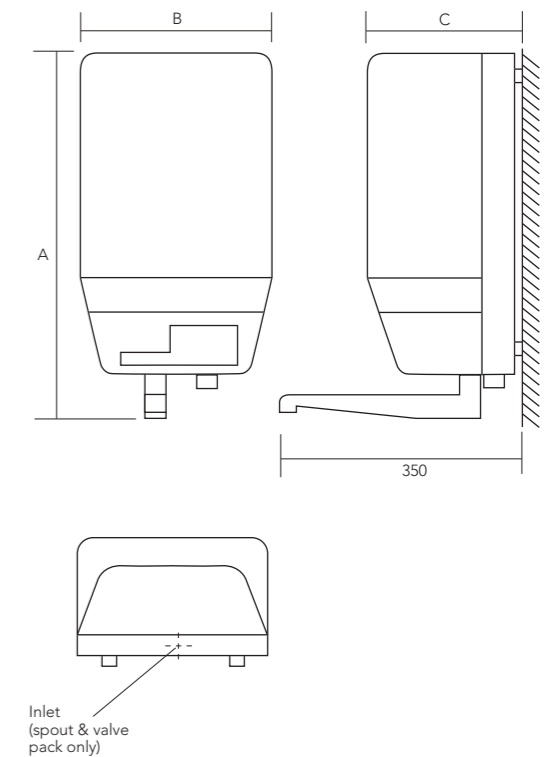

Model	A (mm)	B (mm)	C (mm)	Capacity (litre)	Rating @240 (kW)	Weight (kg)	
						empty	full
Streamline	530	290	152	7	1	4	11
Streamline	530	290	152	7	3	4	11
Streamline	530	290	186	10	1	5	15
Streamline	530	290	186	10	3	5	15

Ordering guide

Model	Capacity (litre)	Rating @ 240V (kW)	Product code
Streamline – heater only	7	1	95:010:180
Streamline – heater only	7	3	95:010:182
Streamline – heater only	10	1	95:010:184
Streamline – heater only	10	3	95:010:186
Streamline – with spout and valve**	7	1	95:010:181
Streamline – with spout and valve**	7	3	95:010:183
Streamline – with spout and valve**	10	1	95:010:185
Streamline – with spout and valve**	10	3	95:010:187
Flow restrictor valve	-	-	95:970:115

** Standard spout and valve (Pack B)



Contact

Specification

T: 01603 420220 F: 01603 420229

E: specifier@heatraesadia.com

After Sales Service

T: 0844 871 1535 F: 0844 871 1528

E: heatraesadiaservice@heateam.co.uk

Web www.heatraesadia.com

National service network

Heatrae Sadia products are inherently reliable and are designed to meet the demanding needs of all users.

A nationwide network of experienced engineers is available to provide fast and efficient on-site service support.

In addition, spare parts for the complete range of products are readily available through a wide variety of stockists.

Heatrae Sadia Heating Hurricane Way Norwich Norfolk NR6 6EA

Heatrae Sadia Heating may introduce modifications to their products from time to time. Consequently, the details given in this brochure are subject to alteration without notice.

95 900 909 Issue 1 © Heatrae Sadia Heating. 2009.

A division of B A X I G R O U P

Brochures for all of our products are available free of charge. Please call our literature hotline on 01603 420127.

Domestic Heating and Hot Water

- Aerheat
- Electric Solar
- Electromax Solar
- Megaflo Solar
- Showers
- Amptec
- Electromax
- Megaflo HE
- Megalife HE

Commercial Hot Water

- B3M / C3M
- FBM
- Handy Dri and Hair Drier
- Immersion Heaters
- Streamline
- Express
- Handy
- Hotflo
- Multipoint
- UTC 99

Drinking Water

- SuperChill
- Supreme



Mixed Sources

Product group from well-managed forests, controlled sources and recycled wood or fiber
www.fsc.org Cert no. XXXXXXXXX
© 1996 Forest Stewardship Council



This product is printed on 50% post consumer recycled paper. That is paper that has been previously used eg. newspapers and magazines. This product is printed using vegetable based inks which are non toxic. Please recycle this product once you have finished with it.