

Installation instructions & user manual

Zip Hydroboil Plus



It's water. Refreshed.

On wall boiling water.

Model number:

303562, 305562, 307562



Table of contents

Intended Use	2
Warnings and precautions	3
Before installation.....	5
Technical specification	6
Installation instructions	
Before you begin	6
Step 1 - Position the Hydroboil Plus	
Positioning.....	6
Step 2 - Fasten to the wall	
Fastening	6
Step 3 - Connection and venting	
Plumbing connections	7
Venting	7
Electrical connections	8
Step 4 - Assembly	
Assembly.....	8
Step 5 - Commission the Hydroboil Plus	
Earth continuity verification	9
Turn the mains power and water on.....	9
Trouble shooting	
Trouble shooting table.....	10
Operation	
LCD menu functions.....	11
Tap & safety lock operation.....	19
Appendix	
Mounting template.....	20
Spare parts.....	21
End of life disposal	23
Cleaning	23
Contact details	24

Intended use

This appliance is intended to be used in commercial applications such as:

- Staff kitchens, shops, offices and other working environments.
- Small hotels and bed and breakfast type environments.
- Catering and similar non-retail applications.



This manual contains important safety and installation instructions for the Zip Hydroboil Plus. Please read all warnings, installation requirements and installation instructions before installing any Zip Hydroboil Plus. This system must be installed in accordance with water supply byelaws, current IEE regulations and relevant local authority byelaws.

Warnings

- ⚡ The Zip Hydroboil Plus must be earthed. The resistance of the earth connection from each exposed metal part must be less than 1Ω.
- All installation and service work must be completed by trained and suitably qualified tradespeople. Faulty operation due to unqualified persons working on this product, or any other Zip product may void warranty coverage.
- Never attempt to install a Zip Hydroboil Plus instant boiling water heater without reading all of the applicable instructions.
- Do not remove the cover of the Hydroboil Plus under any circumstances without first isolating it from the power supply.
- In hard water areas mineral scale accumulation in the boiling chamber of the Zip Hydroboil Plus may become a problem, consideration should be given to the maintenance required. A suitable form of water treatment may be necessary.
- The Zip Hydroboil Plus instant boiling water heater is not intended for use by young children or infirm people without supervision.
- Young children should be prevented from having access to ensure that they are not able to use or play with the Hydroboil Plus.
- Do not use strong, corrosive or abrasive cleaners to clean the case of the Hydroboil Plus.
- The ambient temperatures this Hydroboil Plus must operate within are 5°C - 50°C.
- The Hydroboil Plus is intended only for indoor use and should never be installed outdoors or be exposed to the elements of nature.
- The Hydroboil Plus must not be positioned in an area that may be cleaned by a water jet. The Hydroboil Plus must not be cleaned by a water jet.
- Frost protection: If the Hydroboil Plus is located where ambient air temperature could fall below 5°C when the Hydroboil Plus is not in use, do not turn off the Hydroboil Plus electrically. This safeguard does not offer the same protection to the connecting pipework and fittings.
- As the installer, it is your responsibility to supply (if necessary) and install all valves as required by local regulations and relevant standards.
- The Hydroboil Plus is rated for 230V 50Hz AC operation.
- Due to the process of continuous improvement, Zip reserves the right to change details mentioned in this manual, without notice.
- Visit www.zipwater.co.uk to ensure you have the latest copy of this document.

Safety

This appliance is not intended for use by persons (including children) with reduced physical, sensory or mental capabilities, or lack of experience and knowledge, unless they have been given supervision or instruction concerning use of the appliance by a person responsible for their safety. For products sold in Europe, this appliance can be used by children aged from 8 years and above and persons with reduced physical, sensory or mental capabilities or lack of experience and knowledge if they have been given supervision or instruction concerning use of the Hydroboil Plus in a safe way and understand the hazards involved. Children should be supervised to ensure that they do not play with the Hydroboil Plus.

The Hydroboil Plus is intended to be used in commercial applications.

Qualifications

If the power cable is damaged it must be repaired only by a qualified technician. To avoid hazards, all installation procedures must be carried out by a suitably qualified tradesperson.

Venting

Sometimes steam and / or boiling water may discharge through a vent outlet or the tap. Ensure the tap body is located so the tap outlet safely dispenses into the drip tray or sink bowl area, and that the vent is plumbed to a safe location, see page 7.

Lifting

Take care when lifting. The Hydroboil Plus may exceed safe lifting limits. If you feel this is beyond your personal capabilities, please seek assistance with the lift. Do not lift the Hydroboil Plus by the tap or any of its connections. Refer to the Technical specification, page 6 for the weight of the product.

Positioning

It is important to ensure the Hydroboil Plus is positioned in an accessible area. The Hydroboil Plus must have it's base mounted in a horizontal position.

Before installation ensure that provision has been made for the following



- Review the technical specifications.
- Ensure the mounting wall can support the product weight when full of water (See Technical specification, page 6).
- Provide sufficient space to install the Hydroboil Plus and other components in accordance with these installation instructions.
- Position the Hydroboil Plus so there is at least 150 mm clearance above it for service access, 65 mm to its left and 20 mm to its right – the tap nozzle is usually positioned nominally 360 mm above a draining board, drip tray or sink bowl area.
- For all Zip Hydroboil Plus models, user easy accessible 1 x 230V AC 13A socket or double pole isolation switch, (correctly rated for the appliance), is required.
- The Hydroboil Plus must be connected in accordance with IEE regulations. See Technical specification, page 6 for power ratings.

Note Check cable and plumbing against inlet /outlet positions before proceeding.

- A wholesome (cat 1) water supply connection with isolating valve within reach of the Hydroboil Plus (and positioned so that the stop cock will not be obstructed when the Hydroboil Plus is installed).
- Vent / outlet drainage to a draining board, drip tray or sink bowl area.
- Access to drainage from a vent situated at the base of the Hydroboil Plus.
- A wholesome (cat 1) cold water supply with a minimum working pressure of: (see Technical specification, page 6 min. / max. water supply pressure).
- A 0.35 MPa (3.5 bar) pressure limiting valve supplied must be fitted if the incoming mains water pressure is likely to exceed 0.5 MPa (5.0 bar).
- The Hydroboil Plus must be placed with its base in a horizontal position.

IMPORTANT! Do not proceed with the installation if these requirements are not met.

Technical specification

Product code	Tank size (litres)	Heat up time (Inlet 15°C)	Heat up time (Inlet 10°C)	Power rating kW@230V	Dimensions (mm) W x D x H	Filled weight(Kg)
303562	3.0	16mins	17mins	1.4	289 x 180 x 431	12.5
305562	5.0	16mins	17mins	2.2	318 x 198 x 465	16.5
307562	7.5	23 min	24 min	2.2	318 x 198 x 578	20.5

Min / Max water supply pressure

Hydroboil Plus.....0.07 MPa (0.7 bar) - 0.5 MPa (5.0 bar)



WARNING If the incoming mains water pressure is likely to exceed 0.5 MPa (5.0 bar), a 0.35 MPa (3.5 bar) pressure limiting valve must be installed in the cold water supply line.

Note Optional Water Block is recommended to be fitted in the water supply line to minimise the potential damage in the event of leakage, call Zip on 0345 6 005 005.

Installation instructions

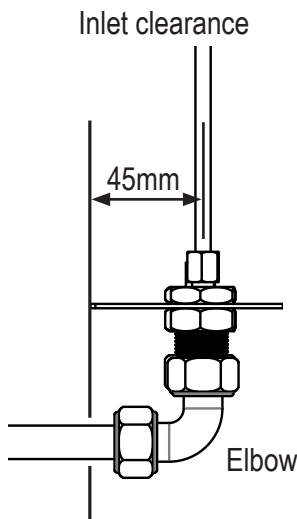
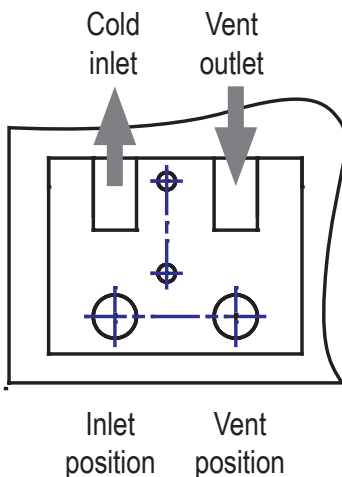

Before You Begin

Locate the paper mounting-hole template packed with the Hydroboil Plus. (Also see page 20).

Read the installation and operating instructions completely.

Decide whether to install with concealed or exposed plumbing connections.

Concealed connections are preferred for superior appearance.

Step 1 – Positioning

- Position the Hydroboil Plus so the nozzle will drain on to a draining board or drip tray.
- Position the base of the tap nozzle to be not less than 280mm (nominally 360mm) above the draining board (height should be increased only if essential for filling larger vessels).
- Provide clearance for service access of not less than 150mm top, 65 mm left, 20mm right.
- Mark corner positions for the Hydroboil Plus on the wall in order to position the paper mounting-hole template.

Step 2 – Fastening

- Position mounting-hole template on wall and drill holes where shown.
- Drill holes for water inlet and vent outlet if rear access is intended.
- Install plumbing and wiring and prepare pipe ends as shown.
- Remove cover fastening screws from Hydroboil Plus and lift off cover.
- Screw Hydroboil Plus chassis to the wall using screws or bolts suited to the wall, (supplied).
- Fasteners must be able to support the product weight when full, (see Technical specification, above).

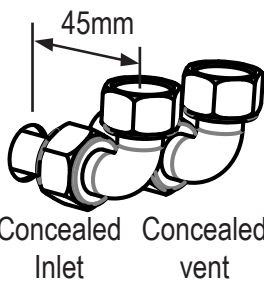
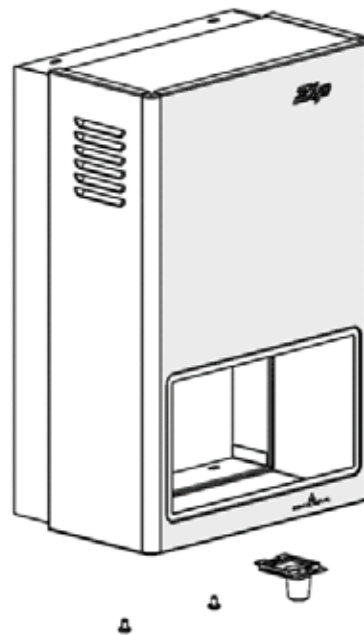
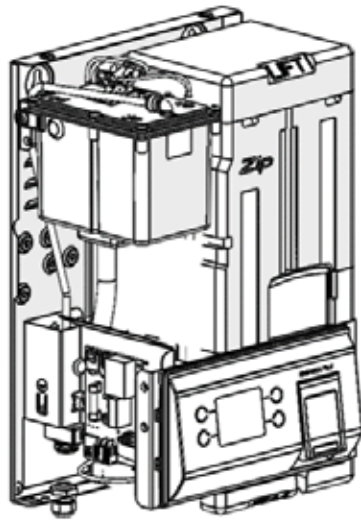

Internal bulkhead connections

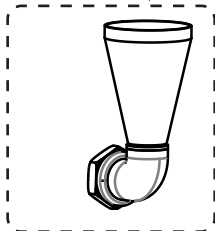
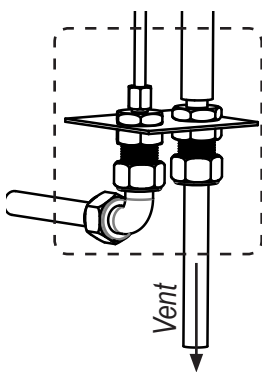

External tundish

Step 3 – Connecting

Plumbing

For exposed plumbing connection, connect the cold water inlet pipe from the base of the Hydroboil Plus directly to the 1/2" BSP compression fittings with nuts and olives supplied.

For concealed plumbing connections, connect the cold water pipe through the rear of the chassis using a 1/2" BSP capillary elbow.

Cold water pipes must be flushed before connection to the inlet. Any clogging due to sediment or fines will adversely affect the operation of the Hydroboil Plus.

The Hydroboil Plus must be installed with an isolating valve which allows it to be isolated from the mains water supply for servicing.

Water pressure requirements. (See Technical specification , page 6).

Venting

A vent at the base of the Hydroboil Plus must be plumbed to a safe location as, under certain conditions, it may discharge cold, boiling water and/or steam.

For concealed or exposed vent plumbing, connect vent outlet from the base of Hydroboil Plus to a Ø15 mm pipe which has a continuous fall, is no more than 3m long, has no more than 3 right angle bends, and discharges to a waste water drain. (the vent outlet must be visible).

For concealed vent plumbing, direct the vent outlet from the rear of the Hydroboil Plus

Alternatively install a visible tundish. (see adjacent diagram) and plumb to trapped waste.

Electrical



- Refer to current IEE guidelines for installation requirements, cable size and selection to ensure suitability for local installation conditions.

- Do not turn the power ON until the Hydroboil Plus can dispense water from the tap outlet.
- Do not connect both options. It is essential that the flex and plug cable is removed from the PCB if the concealed connection is used. Otherwise the mains plug will become live.

Exposed electrical connection

- See diagram below.
- Connect to a 13A socket via the 3 core pre-fitted cable.
- Ensure that the 3 core cable is connected to the PCB via connector (J1) on the PCB.
- Ensure that the strain relief bush is tightened to secure the cable.

Concealed electrical connection

- See diagram below.
- Disconnect the pre fitted cable & discard.
- Connect a 1.5mm² 3 core cable to a 13A supply through the rear access opening to the terminal block J4 on the PCB via the strain relief bush.
- Tighten the strain relief bush, to secure the cable.
- Crimp a 6.3mm QC female spade connection to the earth conductor & attach to chassis earth.
- Verify earth continuity (see page 9).

Mains electricity supply connections

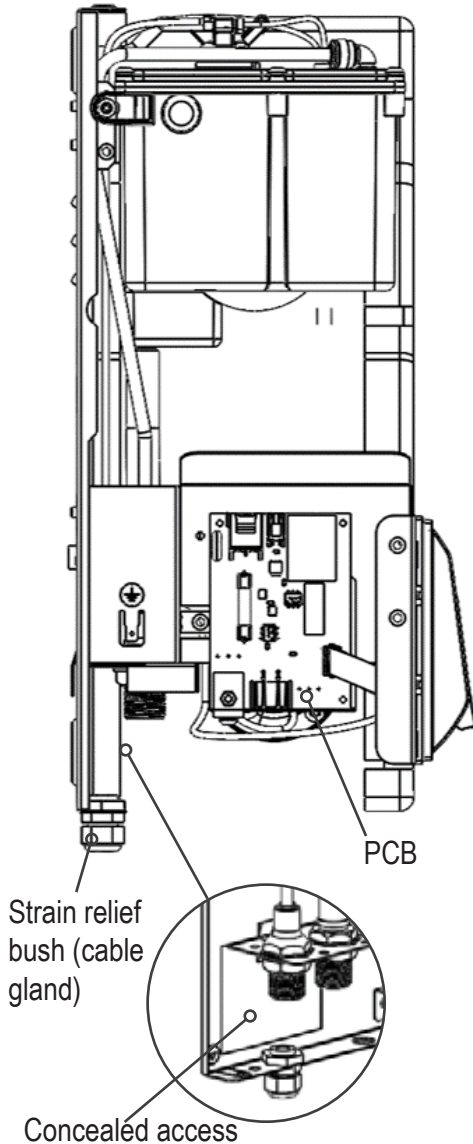
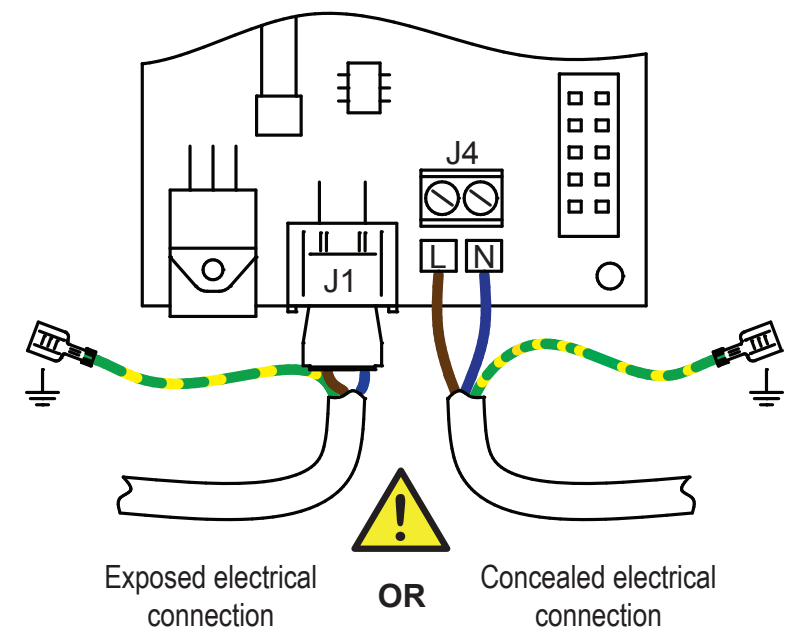

Step 4 - Assembly

- Without the cover on, turn the water on to check for any leaks. These should become apparent within a short period of time. If all is dry then isolate water and replace cover. If there are any leaks repair as necessary.

Step 5 – Commissioning

- Check previous steps.
- Check the earth continuity (see below).



Warning This appliance must be earthed

Upon installation or following service, the earthing continuity of the Hydroboil Plus must be tested by a qualified technician using a resistance meter of minimum accuracy of 5% full scale deflection.

- Isolate power supply.
- Verify meter ohms range, connect leads together, reading should be 0 ohms.
- Connect one test lead to the earth of the power lead.
- Connect the other test lead to a cover fixing screw, then the tap.



Warning The water may be boiling

- Verify that in every instance the electrical resistance does not exceed 1 ohm.

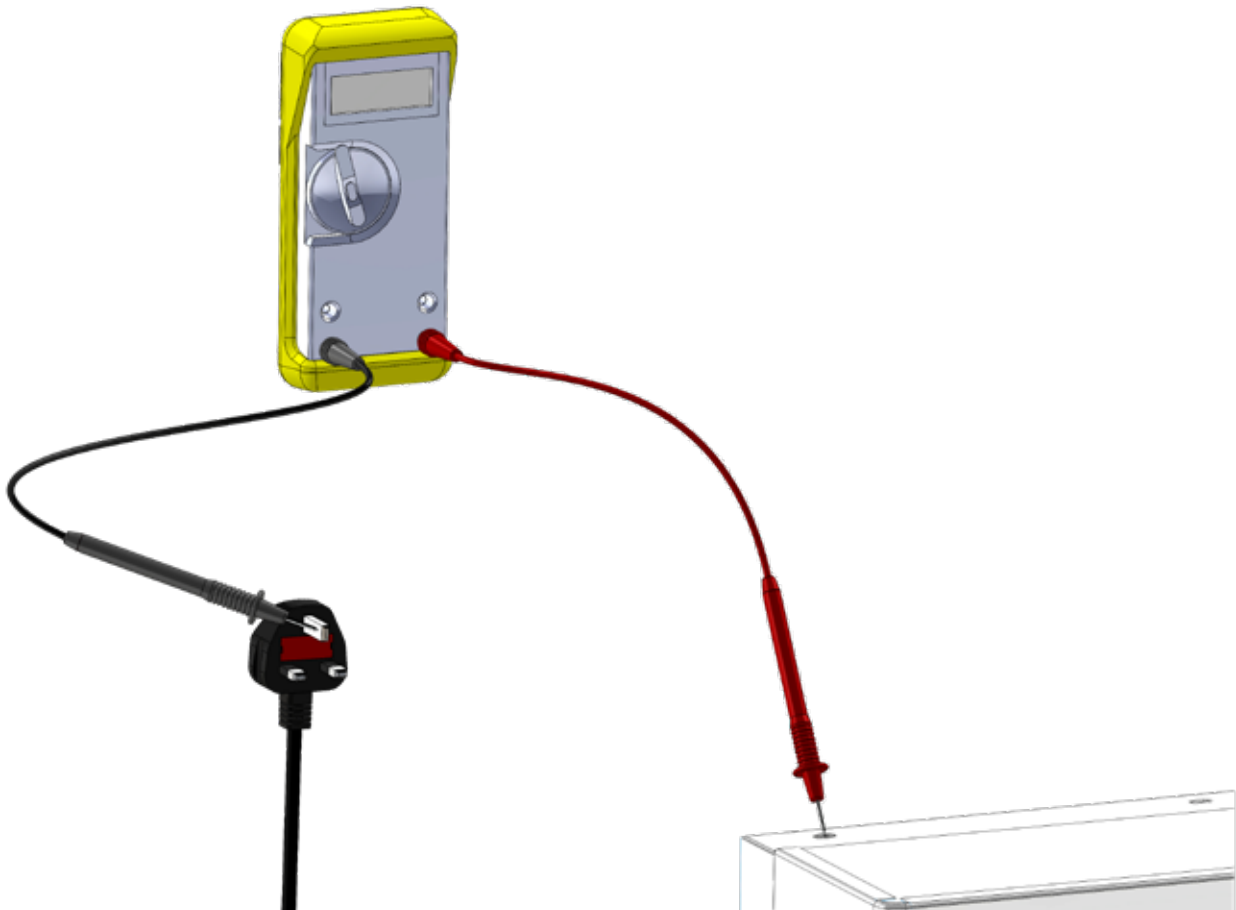

Do not turn the power ON until the Hydroboil Plus can dispense water from the tap outlet.

- Turn water supply ON. Water will flow into the Hydroboil Plus, check connections for leaks. Wait approximately 5 minutes then pull the tap forward to test for water flow.
- Turn the mains electrical power ON only after the water flows freely from this outlet.
- After a short period, boiling water will be available and will be maintained close to boiling point thereafter.

Trouble-shooting table

Symptom	Possible cause	Solution
Fails to dispense water.	Water isolating valve turned off. Blocked filter, blocked meter tube, blocked strainer, jammed ball valve assy, airlock in transfer tube.	Check water supply valve. Contact Zip authorised agent.
Water not boiling.	No power. Faulty PCB, faulty element, faulty cut-out.	Check power supply. Contact Zip authorised agent.
Runs out of boiling water and fails to refill. Outlet tap drips. Overflow from vent. Excessive steam from vent. Power "on" but no heat. Overload repeatedly tripping with excessive steam. Overload repeatedly tripping without excessive steam.	Internal adjustment.	Contact Zip authorised agent.

1 Understanding icons and buttons

The Hydroboil uses a display and button menu system for setup and operation adjustment.

The display does not have a touch screen feature. The side buttons are used to navigate, perform selections and modify values.

The icon changes according to the button action. A button has no function when no icon is shown.

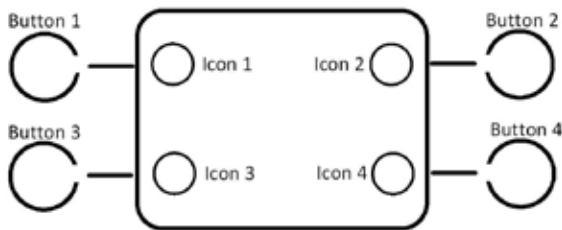

 Move to the next item able to be highlighted.

 Move to the previous item able to be highlighted.

 Confirm menu selection

 Move to the previous menu.

 Perform one of 3 functions:

- Move to the menu titled by the highlighted item.
- Select the currently highlighted item to adjust it.
- Confirm the value of a selected item.

 Increment the item selected.

 Decrement the item selected.

2 Home screen modes

- There are 3 Home screen modes, detailed as follows:
- Normal mode.
- Energy mode.
- Energy override mode.

2.1 Normal mode

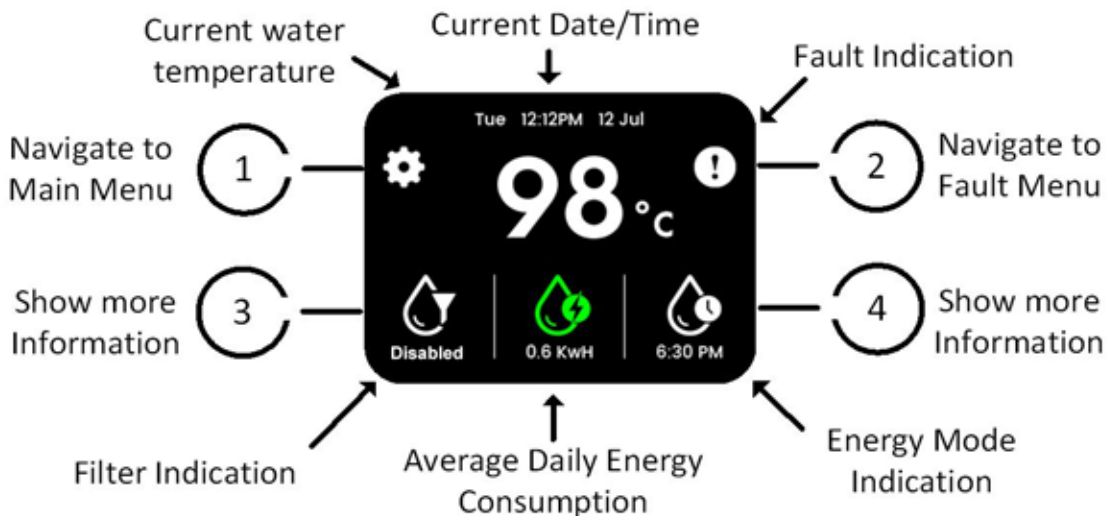

Button 2 shows faults information.

Button 3 shows more information about the filter life.
Using  to navigate to the filter life settings menu.

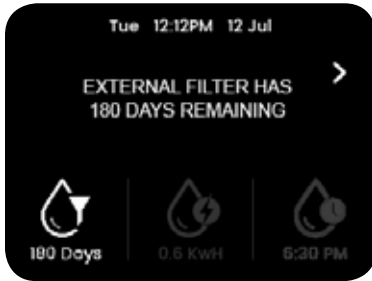



Note If filter life has been disabled in the settings menu, 0 Days remaining will be shown in this information screen. This is the default option.

Button 4 will show more information about the energy mode settings.

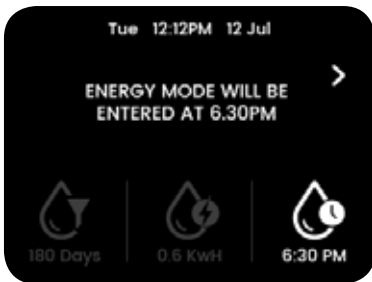
Using  to navigate to the energy mode settings menu.



Fault indication



-  There are no current faults.
-  There are current faults.

Filter indication

-  Days remaining of filter life.

Note Disabled will be shown under this icon if filter life has been disabled in the settings menu. This is the default option.



Energy mode indication

-  Hydroboil will enter energy mode at the time shown.
-  Hydroboil will enter energy mode when it is dark.
-  All energy saving modes are disabled.

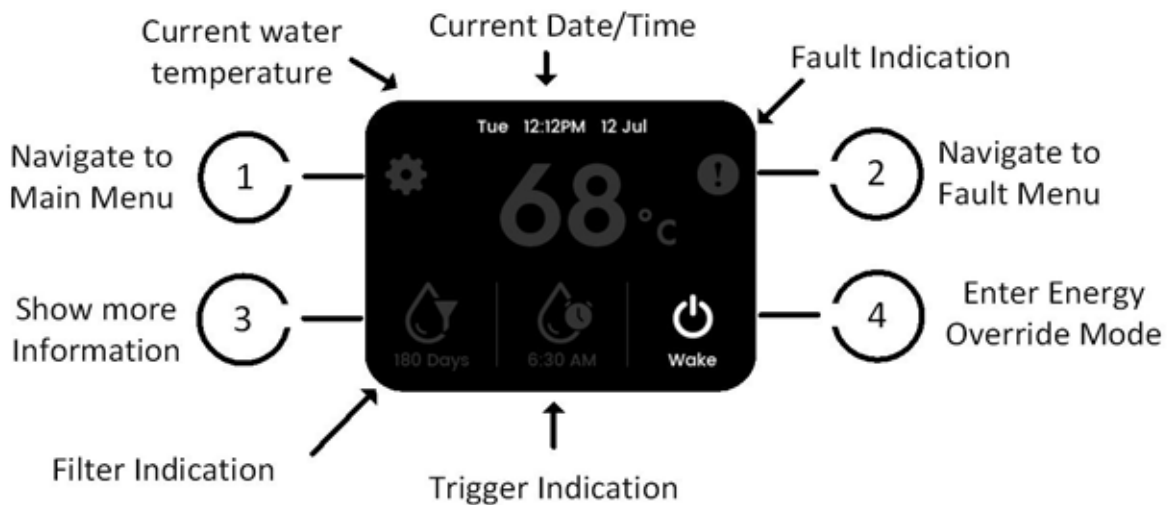
2.2 Energy mode



Trigger Indication

-  Hydroboil will exit energy mode at the time shown.
-  Hydroboil will exit energy mode when ambient light returns to normal (bright room).

2.3 Energy Override Mode

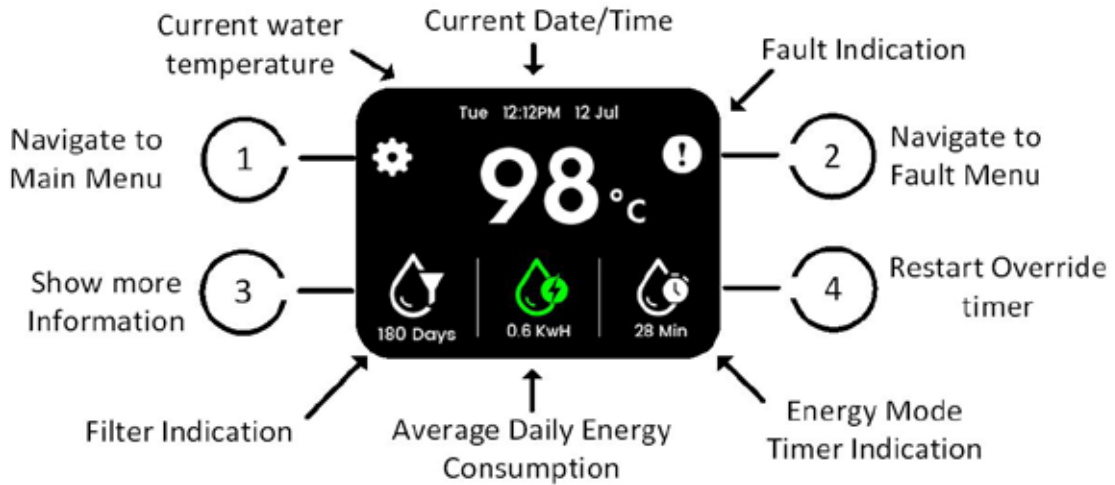

Energy Mode Timer Indication

Hydroboil will return back to the energy mode after this time. Button 4 will restart the timer.

3 MAIN menu

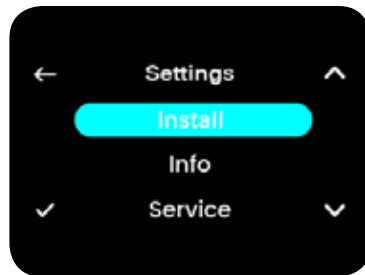

- To navigate to the main menu.

4 SETTINGS menu

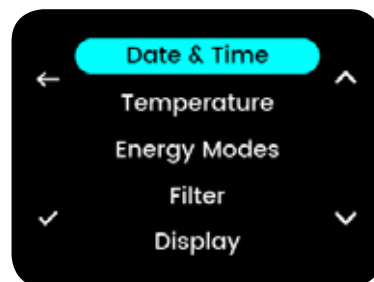
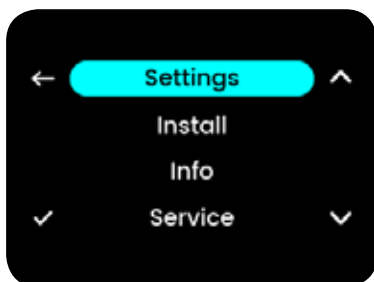

- Symbol to navigate to the main menu.
- Scroll menu options.
- Settings Choose option.
- Select option.

Choose and select options from the settings menu, in the following section in the same manner as above.

4.1 SETTINGS - date / time

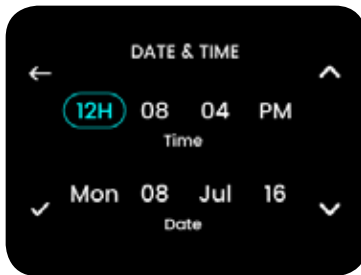

To navigate to, and use the Date & time screen.

- Symbol to navigate to the main menu.
- Scroll menu options.
- Choose option.
- Select option.
- Scroll menu options.
- Choose option.
- Select option.
- Scroll parameters.
- Select parameter.
- Modify parameters.
- Confirm value.
- Exit and return to previous screen.

4.2 SETTINGS - temperature

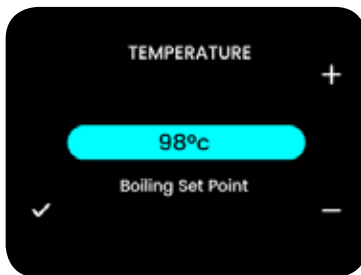

To navigate to, and use the Temperature screen.

- Symbol to navigate to the main menu.
- Scroll menu options.
- Choose option.
- Select option.
- Scroll menu options.
- Choose option.
- Modify parameters.
- Exit and return to previous screen.

4.3 SETTINGS - energy modes

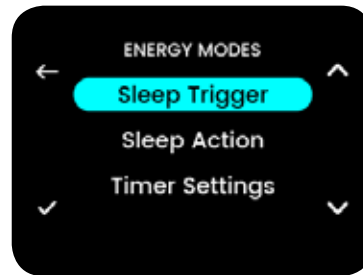

To navigate to, and use the Energy modes screen.

- Symbol to navigate to the main menu.
- Scroll menu options.
- Choose option.
- Select option.
- Scroll menu options.
- Choose option.
- Select option.
- Scroll menu options.
- Choose 1 of 3 options.
-
-
- Scroll parameters.
- Select option.

4.3.1 Energy modes - sleep trigger

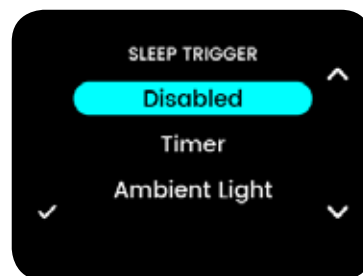

- The Hydroboil will not enter its energy mode.
- The Hydroboil will use the on /off timer settings to enter and exit its energy mode.
- The Hydroboil will enter its energy mode when darkness is detected and will exit its energy mode when the ambient light returns to a normal level.

- Scroll menu options.
- Select option.

4.3.2 Energy modes - sleep action



68°C While the unit is in its energy mode the set point of the water will be reduced to 68°C.

Off While the unit is in its energy mode no heating of the water will occur.

- Scroll options.
- Exit and return to previous screen.

4.3.3 Energy modes - timer settings

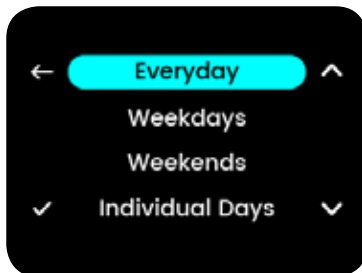

Everyday Adjust on/off timer settings for all 7 days simultaneously.

Weekdays Adjust on/off timer settings for all 5 weekdays simultaneously.

Weekends Adjust on/off timer settings for the 2 weekend days simultaneously.

Individual Days Adjust on/off timer settings for the 7 days separately.

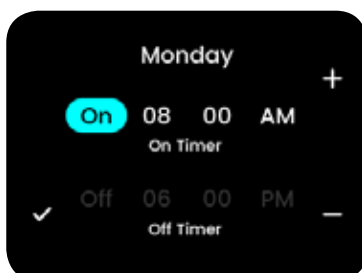

- **Everyday** Choose 1 of 4 options.
- **Weekdays**
- **Weekends**
- **Individual Days**
- Select option.
- Scroll parameters.
- Select parameter.
- Modify parameters.
- Confirm value.
- Exit and return to previous screen.

4.4 SETTINGS - filter

To navigate to, and use the Filter screen.

- Symbol to navigate to the main menu.
- Scroll menu options.
- **Settings** Choose option.
- Select option.
- Scroll menu options.
- **Filter** Choose option.
- Select option.

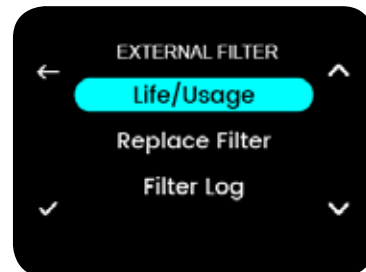

- Scroll menu options.
- Select option.

4.4.1 Filter - filter life / usage

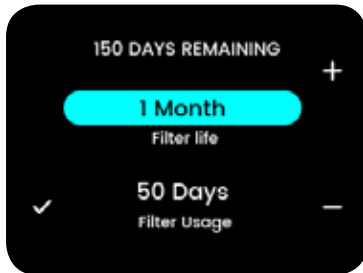
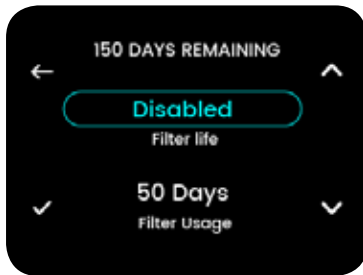

Allows modification of filter life and usage parameters.

Filter life options are as follows.

- Disabled** Filter replacement reminder will not appear on home screen.
- 1 Month** Filter replacement reminder will appear as set at 1-14 months (default 12 months).

Filter Usage

- 50 Days** Automatically increments daily. Reset to [0 Days] when the filter is reset. Can be adjusted if a partially used filter is inserted.

The days of filter life remaining on the home screen are based on these 2 parameters.

To navigate between options.

- Scroll menu options.
- Select option.

4.4.2 Filter - replace filter

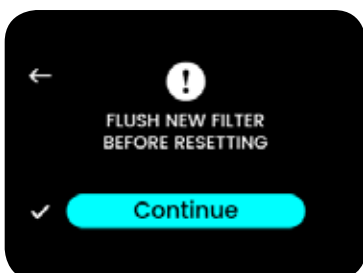

This action will reset the filter usage counter. A reminder will appear, to flush the new filter before resetting.

- Continue
- Select

4.4.3 Filter - filter log



The log displays the dates that the filter usage counter was reset and the days of filter life remaining.

- Scroll to view log history.

4.5 SETTINGS - display



Show / hide energy consumption on the home screen.

Enable / disable backlight dimming after 4 minutes without buttons being pressed.

To navigate to, and use the display screen.

- Symbol to navigate to the main menu.
- Scroll menu options.
- Settings Choose option.
- Select option.
- Scroll menu options.
- Display Choose option.
- Select option.
- Scroll menu options.
- Enable Display energy
- Enable Backlight timer
- [Enable /Disable]
- Select option.

5 INSTALL menu

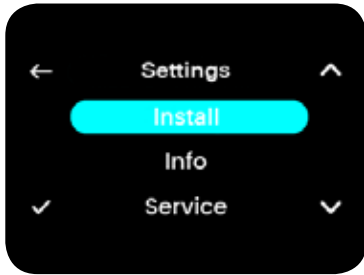

- Symbol to navigate to the main menu.
- Scroll menu options.
- Choose option.
- Select option.

5.1 INSTALL - light calibration

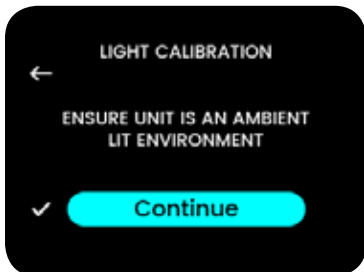

- Calibrate the light sensor, for energy modes.
To navigate to, and use the light calibration screen.
- Symbol to navigate to the main menu.
 - Scroll menu options.
 - Choose option.
 - Select option.
 - Scroll menu options.
 - Choose option.
 - Select option.
 - To calibrate.
 - Display will confirm that the Hydroboil is calibrating.
 - Display will confirm calibration.
 - To return to the Install menu.

5.2 INSTALL - boiling calibration

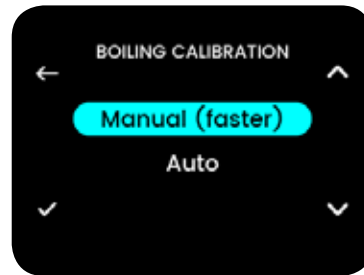

Undertake the boiling calibration.

To navigate to, and use the boiling calibration screen.

- Symbol to navigate to the main menu.
- Scroll menu options.
- Choose option.
- Select option.
- Scroll menu options.
- Choose option.
- Select option.
- Scroll menu options.
- Choose option.
- Choose option.
- Select option.
- Follow on-screen instructions to complete the calibration.
- To return to the install menu.

5.3 INSTALL - power cycle

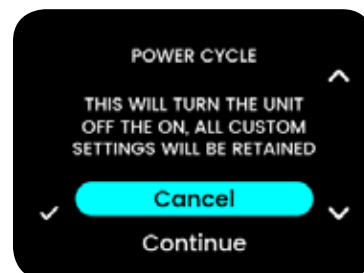

Hydroboil turns off, then back on.

To navigate to, and use the power cycle screen.

- Symbol to navigate to the main menu.
- Scroll menu options.
- Choose option.
- Select option.
- Scroll menu options.
- Choose option.
- Select option [Continue / Cancel].
- To confirm.

6 INFO menu

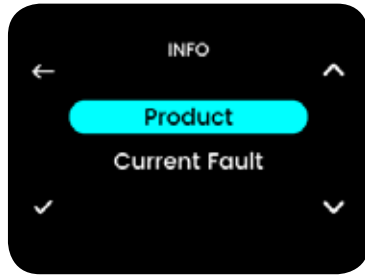
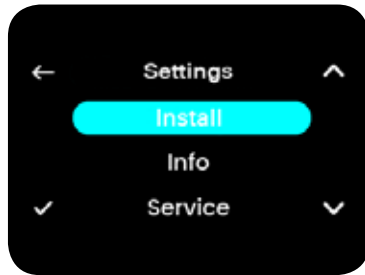

Product

To view product info.

Current Fault

To view the current fault log.

To navigate to, and use the info screen.

- Symbol to navigate to the main menu.
- Scroll menu options.
- **Info** Choose option.
- Select option.
- Scroll menu options.
- **Product** Choose option.
- **Current faults**
- Select option.

6.1 INFO - product



To view model, product, serial number and firmware version of the Hydroboil.

- Scroll menu options.
- To return to previous menu.

6.2 INFO - current faults



To view the current fault log of the Hydroboil

- Scroll menu options.
- To return to previous menu.

Tap Operation

Safety lock

Zip Hydroboil Plus has a unique safety device designed to reduce the incidence of accidental operation of the tap. The tap can be "Locked" to prevent the Hydroboil Plus from dispensing boiling water.

In order to "lock" the tap, ensure the safety button is protruding from the right hand side of the control panel and the locked indicator is illuminated.

This can be achieved by pressing the button and simultaneously rotating it until the groove in the head of the button faces toward the body of the appliance. In this position an internal spring will push the button out. Once the button is in the extended position, the tap will be "Locked" and unable to dispense hot water.

Disengage safety feature:

Press and simultaneously rotate (aprox. 90 degrees) the safety button on the right hand side of the control panel, until it latches in the closed position, and the unlocked indicator is illuminated.



The unit is now capable of dispensing boiling water without the safety feature.

To dispense boiling water

Zip Hydroboil Plus is fitted with a safety, two-way cool-touch safety tap for instant boiling water.

Normal operation (for filling cups and small containers).

To activate the tap, press the safety button (if locked) on the right side of the control panel and while holding the button in, gently push the lower end of the tap paddle inwards and boiling water will flow until the tap paddle is released. Without the lock activated just gently push the tap paddle and release when finished.

Continuous operation (for filling, tea pots, saucepans and large containers).

Press the safety button (if locked) on the right side of the control panel and while holding the button in, lift the tap paddle until it locks into a horizontal position, the button can now be released and boiling water will flow until the paddle is returned to its normal vertical position. This operation allows a vessel to be filled without holding your hand where it may be affected by steam.

Without the lock activated just lift the tap paddle until it locks into place, return paddle to normal position to stop water flow.

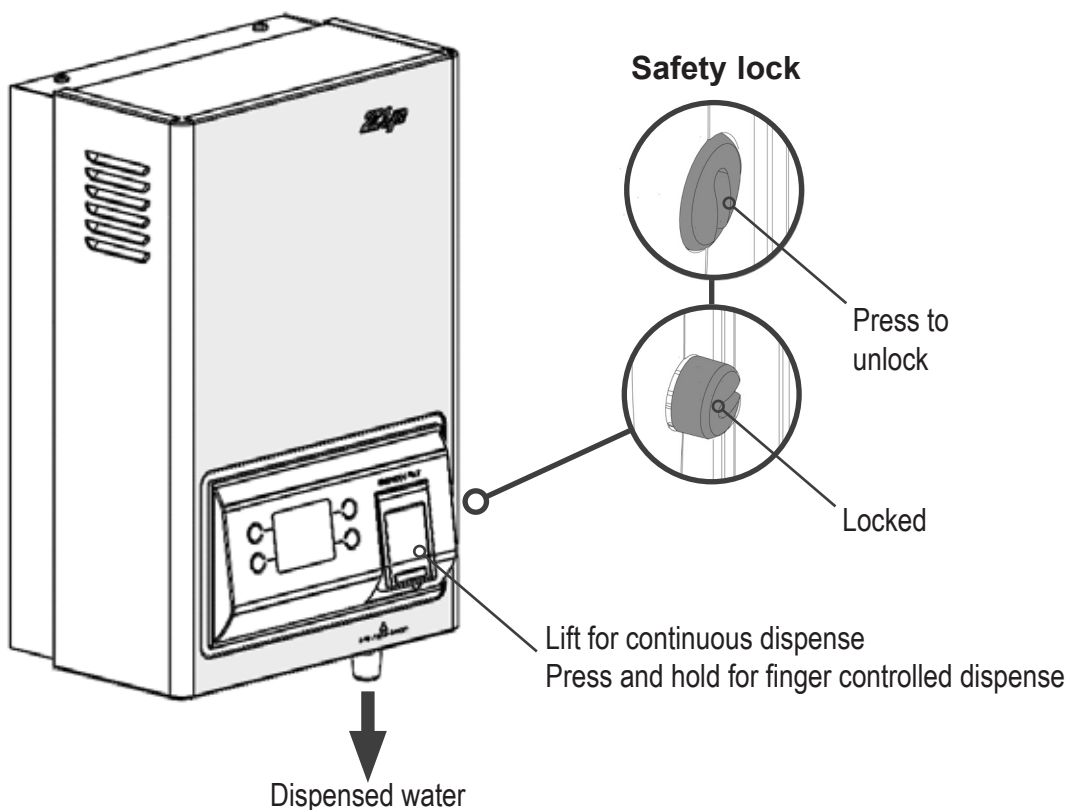

Wall mounting dimension

Dimensions in mm
Not to scale

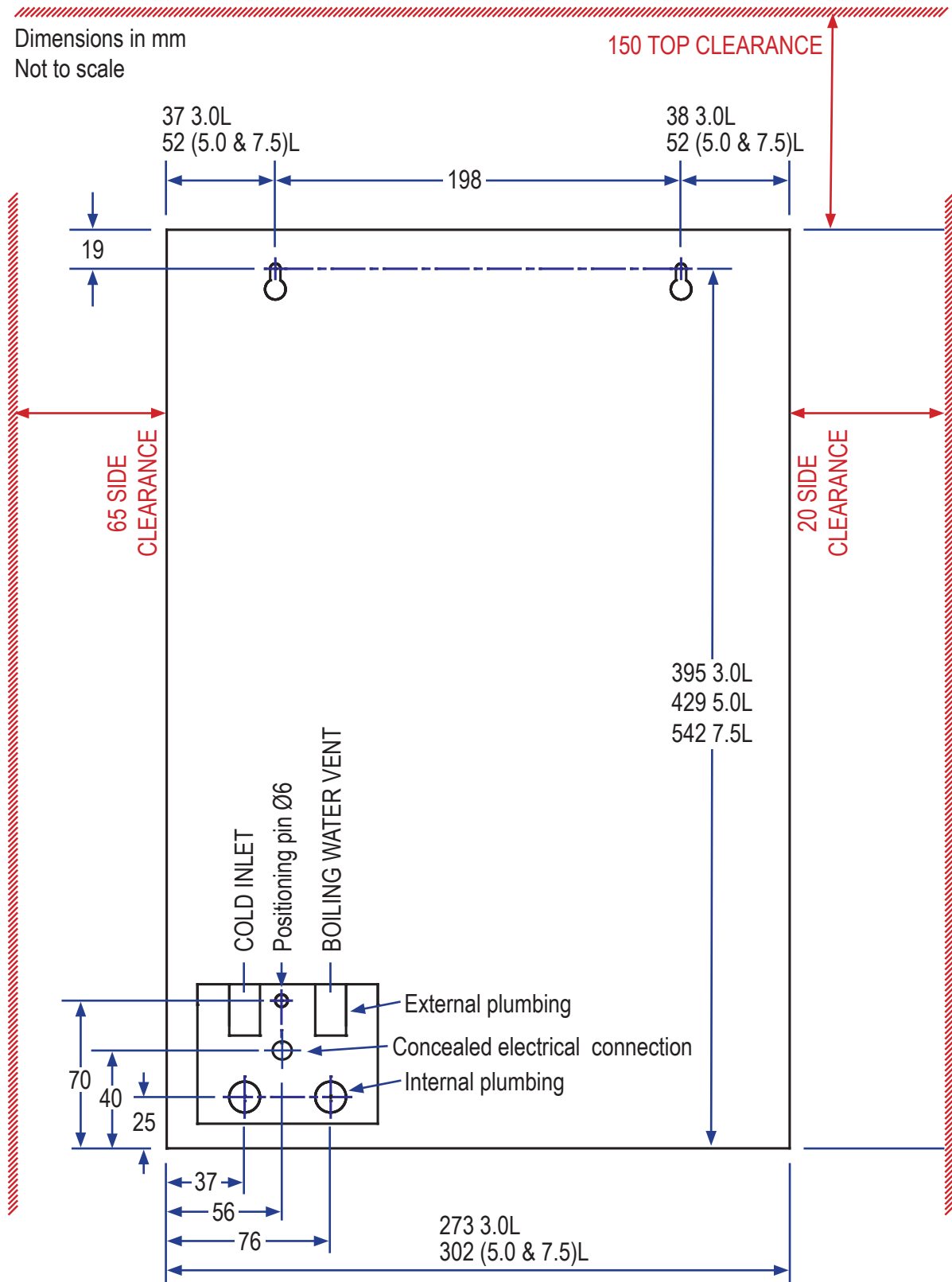

Spare parts

Item	Kit no	Description
1	94443	HB 3Ltr Tank Assy
	94444	HB 5Ltr Tank Assy
	94445	HB 7.5Ltr Tank Assy
2	94761	Fascia HBPlus UK
3	94449	Loom Ther-Overload
4	94454	Cistern Tank
5	94755	Ball Valve Assy
6	94456	Cistern Gasket
7	94457	Cistern Lid
8	SP93118	Elbow Stem 1/4"
9	90100	Grommet, Cistern to Tank
10	94458	Overload 4 terminal, 2 pole, 90 deg
11 & 12	SP90494	Metering tube & seals kit
13	SP90485	Element Assy 1500W 3Ltr
	SP90486	Element Assy 2400W 5 & 7.5Ltr
14	94465	Bush Vent Assy 3Ltr
	94466	Bush Vent Assy 5Ltr
	94467	Bush Vent Assy 7.5Ltr
15	94757	UK Inlet Assy
16	94495	Grommet Blank
17	94473	Hot Tank Gasket Kit 3Ltr
	94474	Hot Tank Gasket Kit 5&7.5Ltr
18	SP90733	Nozzle Outlet
19	94501	Tap Assembly for Hydroboil Plus
20	SP91440	Boiling temperature sensor probe
21	94481	Ribbon Cable
22	94482	PCB Powerboard
23	94613	Steam sensor NTC

Spare parts

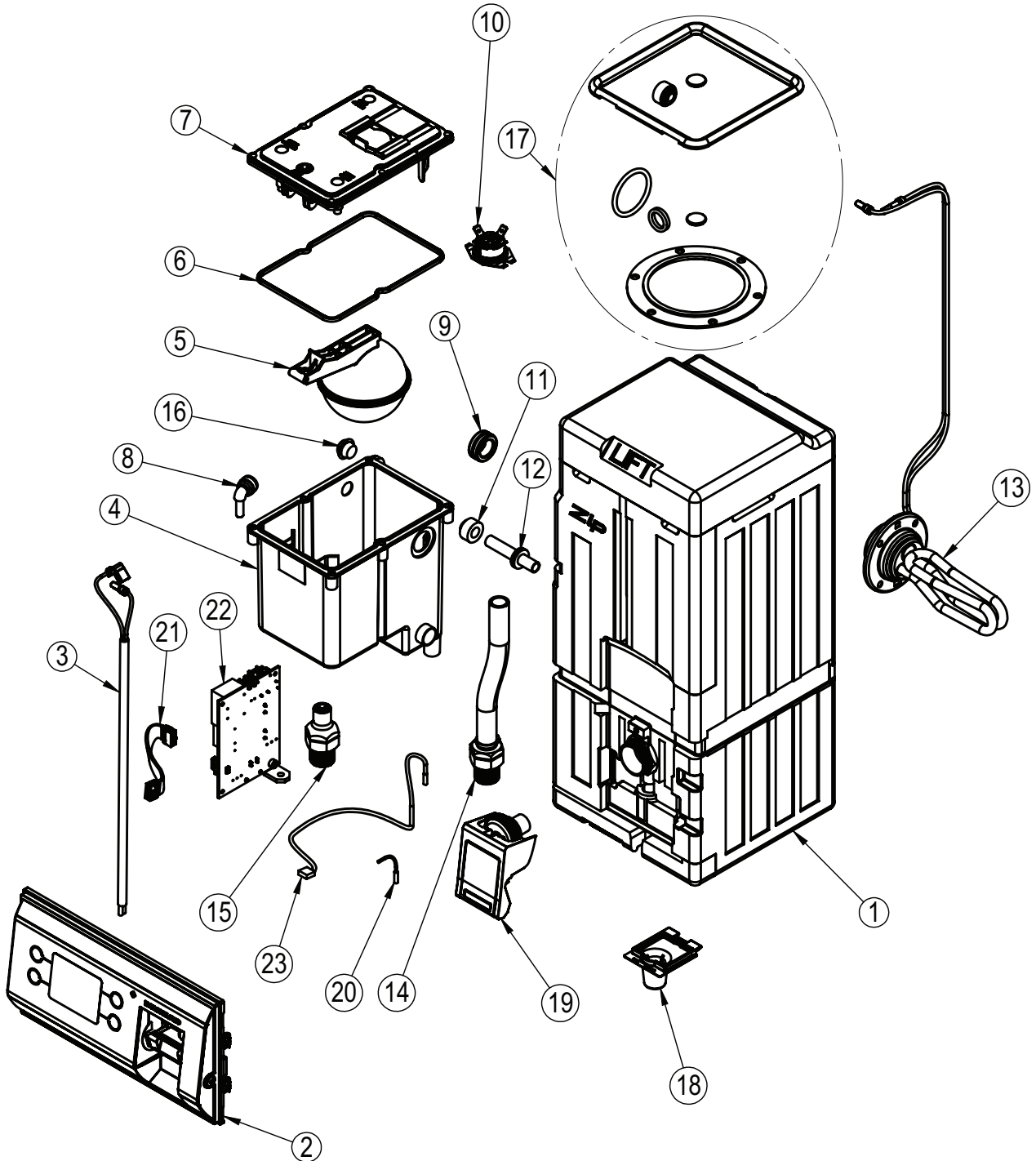

End of life disposal



The use of this crossed out wheeled bin logo indicates that this product needs to be disposed of separately to any other household waste.

Within each of the European Union member countries, provisions have been made for collection and recycling of unwanted electrical and electronic equipment. In order to help preserve our environment we ask that you dispose of this product correctly. Please contact Zip Customer Service on 0345 6 005 005 for advice.

Cleaning

Cleaning the case

Do not use strong, corrosive, spray or abrasive cleaners. Clean the case with a soft cloth or brush and mild soap and water.





It's water. Refreshed.



Zip Water UK
14 Bertie Ward Way, Dereham, Norfolk NR19 1TE
0345 6 005 005 sales@zipindustries.co.uk

www.zipwater.co.uk