



Instanta

# InstaTap

Commercial Under-Counter, Push-Button Dispensers

I2CB10-I2CB50, all models

I2CBC1020, all models



Instanta verified original instructions: EN version.

# Table of contents

SECTION 1 Using these instructions .....	4
Before you start .....	4
Explanation of symbols .....	4
Explanation of acronyms .....	4
SECTION 2 IMPORTANT SAFETY INSTRUCTIONS.....	4
SECTION 3 WARNINGS & REGULATORY INFORMATION.....	7
SECTION 4 Technical data .....	9
4.1 Explanation of product codes for complete range .....	9
4.2 Technical data tables .....	11
SECTION 5 Components supplied .....	13
SECTION 6 Installing the under counter appliances.....	14
6.1 Positioning and ventilation - in cupboard installation .....	14
6.2 Positioning and ventilation - under counter top installation.....	15
6.3 Pipes and tubes .....	16
6.4 I2CB10 General in cupboard arrangement.....	16
6.5 I2CBC1020 General in cupboard arrangement.....	17
6.6 I2CB20 - I2CB50 General arrangement - single font model shown.....	18
6.7 Push fit best practice.....	19
6.8 Connect the water supply.....	20
6.9 Water block.....	22
6.10 Manifold connections and controls .....	23
6.11 I2CB20 - I2CB50 Overflow & drain.....	25
6.12 Earth continuity test, UCB & UCC .....	26
6.13 Connect the electricity supply .....	27
SECTION 7 Commissioning.....	28
7.1 At first switch on .....	28
7.1.1 B**UC Under counter boilers .....	28
7.1.2 C20UC Under counter chiller (UCC) .....	29
SECTION 8 Operation.....	30
8.1 Tap controls.....	30
8.2 Safety lock (boiling chilled models only) .....	31
8.3 To dispense boiling water .....	32
8.4 Dispense chilled water .....	33
8.5 Adjust the chilled water flow rate from the UCC.....	33

# Table of contents

8.6 Set up the fixed volume dispense .....	34
SECTION 9 Maintenance .....	35
9.1 Replace ,flush and reset the filter.....	35
9.1.1 Replace the FL500 filter .....	35
9.1.2 Flush the filter .....	36
9.1.3 UCB filter monitor settings.....	37
9.1.4 Adjust the UCB boiling water temperature.....	37
9.1.5 Set the temperature .....	37
9.1.6 Set the filter monitor .....	38
9.2 Cleaning .....	39
9.2.1 Cleaning the aerator .....	39
SECTION 10 Service warnings and troubleshooting.....	40
Environmental information .....	42
Warranty.....	43

## SECTION 1 Using these instructions

### Before you start



Read and use the instructions supplied with individual kit components for a safe installation.

This manual is also available at our website [www.instanta.com](http://www.instanta.com)

### Explanation of symbols



Read the instructions



WARNING



Danger of electric shock



Hot surface



Highly flammable

### Explanation of acronyms

UCB - Under counter boiler, UCC - Under counter chiller.

## SECTION 2 IMPORTANT SAFETY INSTRUCTIONS



### Compliance

In the UK the system must be installed in accordance with water supply byelaws, current IEEE regulations and local authority byelaws.

### Safety

This appliance is not intended for use by children under 8 years or persons (including children under 8 years) with reduced physical, sensory or mental capabilities, or lack of experience and knowledge, unless they have been given supervision or instruction concerning the use of the appliance by a person responsible for their safety. Children should be supervised to ensure that they do not play with the appliance.

Cleaning and user maintenance shall not be made by children without supervision.

## SECTION 2 IMPORTANT SAFETY INSTRUCTIONS

### Refrigerant



**WARNING! KEEP VENTILATION OPENINGS IN THE APPLIANCE ENCLOSURE OR IN THE BUILT-IN STRUCTURE CLEAR OF OBSTRUCTION.**



**WARNING! DO NOT DAMAGE THE REFRIGERANT CIRCUIT.**

The InstaTap chiller range use **HIGHLY FLAMMABLE R290** refrigerant under pressure.

Check the rating plate or contact Instanta before commencing work.

Maintenance of the refrigeration unit must be carried out by an accredited service provider or qualified refrigeration technician.

Do not use mechanical devices or other means to accelerate the defrosting process, other than those recommended by the manufacturer.

### Refrigeration equipment

The chiller must be transported in an upright position.

### Qualifications

To avoid hazards, all installation procedures must be carried out by a suitably qualified tradesperson. The power cable and power outlet must be in a safe visible position for connection.

### Venting

Sometimes steam and / or boiling water droplets may discharge through the vent / overflow outlet on the InstaTap. Ensure that the vent / overflow is directed to waste via a 20mm air gap on applicable models.

### Lifting

Take care when lifting. The InstaTap may exceed safe lifting limits. If you feel this is beyond your personal capabilities, please seek assistance with the lift. Do not lift the InstaTap by the front cover or any of its connections.

### Airflow

The InstaTap operates within the ambient temperature range 5°C - 30°C. Proper air circulation must be provided. The system will operate satisfactorily only if the recommended air gaps are provided.

## SECTION 2 IMPORTANT SAFETY INSTRUCTIONS

### **Frost protection**

This appliance is not designed for outdoor use.

Ensure that the appliance is not installed in an area where the ambient air temperature cannot fall below 5°C.

If the ambient air temperature should fall below 5°C when the system is not in use, do not turn off the appliance electrically to prevent it from freezing. This safeguard does not offer the same protection to the connecting pipework and fittings.

### **Service and maintenance**

Access to the interior of the appliance is restricted. A screwdriver is required to remove the access covers.

### **Application**

The appliance is intended to be installed in a commercial or catering environment, where it is supervised by a trained operator, who can also train staff in its safe use.

### **Special national conditions**

This appliance does not comply with special national conditions for Denmark, Sweden, Finland and Norway.

### **Mains plug**

This appliance is supplied for the UK market and is supplied with a UK mains plug compliant with BS1363.

## SECTION 3 WARNINGS & REGULATORY INFORMATION



**FOR CONTINUED SAFETY OF THIS APPLIANCE IT MUST BE INSTALLED, OPERATED AND MAINTAINED IN ACCORDANCE WITH THE MANUFACTURER'S INSTRUCTIONS.**

-  The InstaTap under counter boiler and under counter chiller must be earthed, earthing is provided via the supplied power cord. The resistance of the earth connection to each exposed metal part must be less than 1Ω. Use the power cable supplied. It is the responsibility of the installer to ensure the power point is earthed.
- All installation and service work must be completed by trained and suitably qualified tradespeople. Faulty operation due to unqualified persons working on this product, may void warranty coverage.
- As the installer, it is your responsibility to supply and install all valves as required by local regulations and relevant standards.
- The InstaTap is rated for 230V 50Hz AC operation.
- Do not remove the cover of the under counter boiler, and under counter chiller, without first isolating them from the power supply.
- Connect only to a potable (wholesome, cat1) mains water supply.
- Never locate the system near, or clean with water jets.
- Do not expose the InstaTap system to the elements of nature it is not suitable for outdoor use.
- A pressure limiting valve must be fitted for mains water pressures above the max. limits stated.
- Use of tools can be hazardous, assess the risks before you start.
- A clearance envelope around the under counter appliances must be provided to allow adequate ventilation and service access for their safe and effective use.
- Valve and fitting threads must be sealed appropriately with PTFE tape where compression seals are not provided.
- Do not over tighten plumbing and hose connections.
- The power cords and power outlets must be in a safe and accessible position after installation. When positioning the under counter

## SECTION 3 WARNINGS & REGULATORY INFORMATION

appliances, ensure power supply cords are not trapped or damaged. If damaged they must be replaced by an Instanta service provider or a qualified electrician.

- Instanta cannot be held responsible for any appliance malfunction if the water pressure exceeds that stated. If in doubt, consult your water supply company.
- The install rail supplied must be fitted to ensure compliance with the S.I.1999 No.1148 The Water Supply (Water fittings) Regulations 1999 Schedule 2 requirement.
- Ensure that all installed silicone tubes are shaded from direct sunlight.
- Instanta cannot be held responsible for limescale related problems even when a lime-scale reducer has been installed.
- As with all refrigeration systems, irreparable damage can be caused by laying the chiller on its side or even transporting upside down.
- If the under counter chiller has been transported incorrectly, it should be placed in the correct upright position and left for 24 hours before attempting to install and commission it. Failure to observe these precautions could seriously damage the refrigeration system.
- All InstaTap models with chilled functionality must be sanitised during installation or the commissioning process, please contact us on 0345 6 005 005 to book a commissioning service.
- If your InstaTap is left idle before use, for water taste and quality reasons, any non-use of more than 48 hours, we recommend a system flush be performed. On first use after a period of non-use, run the chilled function for 60 seconds to flush the filter and system. Not flushing the system may affect the water quality. If taste or water quality issues persist, a filter change and sanitisation may be required.
- The new detachable hose sets supplied with the appliance must be used. Do not re-use old hose sets.
- Place the appliance in an environment suitable for its size and use, making sure that it is placed in a horizontal position, make sure that the appliance does not have an inclination greater than 2°.
- The appliance does not use materials containing flammable blowing



## SECTION 3 WARNINGS & REGULATORY INFORMATION

gases.

- The IC20UC\* chiller is rated as Climate Class N : it's functional temperature range is +5°C to +32°C.
- The appliance does not contain asbestos or oils containing polychlorinated biphenyl.
- Do not connect the appliance outlet to any other tap or fitting.

## SECTION 4 Technical data

### 4.1 Explanation of product codes for complete range

#### Complete appliance code

Product group	Generation	Market	Function	Boiling Capacity (l)		Chilled Capacity (l)	
I InstaTap	G1	Office SME	B Boiling	5	5	No chilled	
	2 G2	C Comm	BC Boiling Chilled	10	10	20	20
	3 G3		C Chilled	20	20		
	4 G4			40	40		
	5 G5			50	50		

Finish	Tap height	Font	kW rating	
Polished S. Steel	Standard Height	Single font	<6.75	
B Matt Black	H High	D Double font	6	6.75
		T Triple font		

#### Example highlighted above

I — 2 — C — B — 50 — 6

IC20UC\* - InstaTap G2 Commercial boiling 50l polished stainless steel 6.75kW

## SECTION 4 Technical data

### Rating plate code - Office models

Function		Boiling Capacity (l)		Location		Sector
B	Boiling	5	5	UC	Under counter	Comm
BC	Boiling Chilled	10	10	UC	Under counter	Office
C	Chilled	20	20			
		40	40			
		50	50			

#### Example highlighted above

BC — 5 — UC — O BC5UCO - Boiling 5l chilled 20l under counter appliance for office

C — 20 — UC C20UC - Chilled 20l under counter

### Rating plate code - Commercial (Comm) models

Function		Boiling Capacity (l)		Location		Sector	Font	kW rating
B	Boiling	5	5	UC	Under counter	Comm	Single font	<6.75
BC	Boiling Chilled	10	10				D Double font	6 6.75
C	Chilled	20	20				T Triple font	
		40	40					
		50	50					

#### Example highlighted above

B — 50 — UC — T — 6

B50UCT6 - Boiling 50 Litre Under Counter Triple font 6.75kW

## SECTION 4 Technical data

### Font code - all models

Product		Function		Finish		Tap height		Font	
F	Font	B	Boiling		Polished S. Steel		Standard Height	S	Safety
		BC	Boiling Chilled	B	Matt Black	H	High		
		C	Chilled						

Example highlighted above

F ——— BC ——— B ——— H ——— S

FBCBHS - InstaTap font boiling chilled matt black high with safety

## 4.2 Technical data tables

### Under counter chiller (UCC)

Specification	Unit	C20UC
Capacity	L	N/A
Dimensions (W x D x H)	mm	180 x 340 x 390
Supply voltage	V AC	230 50Hz
Power rating	kW	1.75
Current rating	A	1.3
Mains water supply pressure	bar (MPa)	2 - 5 0.2 - 0.5
Fill type		Automatic
Recovery per minute	L	0.33
Water temperature	°C	5 - 9
Weight (empty)	kg	17
Weight (full)	kg	19
Mains water connection		3/4" BSP (Install rail 15mm)
Fuse rating	A	5
A weighted emission sound pressure	dB(A)	less than 70

## SECTION 4 Technical data

### Under counter boilers I2CB10-50

Specification	Unit	B10UC models	B20UC models
Capacity	L	10	20
Dimensions (W x D x H)	mm	230 x 415 x 520	390 x 475 x 568
Supply voltage	V	230 50Hz AC	230 50Hz AC
Electrical supply	A	13 (1 phase)	13 (1 phase)
Power rating	kW	2.8	2.8
Fuse rating	A	13(T)	13(T)
Mains water pressure	bar (MPa)	2 - 5 0.2 - 0.5	2 - 5 0.2 - 0.5
Fill type		Automatic	Automatic
Max rapid draw-off	L	10	20
Output per hour	L	30	30
Water temperature*	°C	default 95	default 95
Weight (empty)	kg	10.5	15.3
Weight (full)	kg	22.5	37.0
Heat up time from cold	mins	24	43
A weighted emission sound pressure	dB(A)	less than 70	less than 70
Mains water connection		3/4" BSP (rail 15mm)	3/4" BSP (rail 15mm)

\*Adjustable

Specification	Unit	B40UC models	B50UC models	
Capacity	L	40	50	
Dimensions (W x D x H)	mm	560 x 510 x 600	560 x 510 x 600	
Supply voltage	V AC	230 50Hz AC	230 50Hz AC	
Electrical supply	A	13 (1 phase)	20A	30A
			1 phase	1 phase
Power rating	kW	2.8	4.5	6.75
Fuse rating	A	13(T)	20(T)	30(T)
Mains water pressure	bar (MPa)	2 - 5 0.2 - 0.5	2 - 5 0.2 - 0.5	
Fill type		Automatic	Automatic	
Max rapid draw-off	L	40	50	
Output per hour	L	30	42	63
Water temperature*	°C	default 95	default 95	
Weight (empty)	kg	24	26	
Weight (full)	kg	68	70	
Heat up time from cold	mins	88	64	42
A weighted emission sound pressure	dB(A)	less than 70	less than 70	
Mains water connection		3/4" BSP (rail 15mm)	3/4" BSP (rail 15mm)	

\*Adjustable

## SECTION 5 Components supplied

### 5.1 Supplied parts checklist



A 0.35 MPa pressure limiting valve must be fitted for mains water pressures above 0.5 MPa, in accordance with local plumbing regulations. (A pressure limiting valve is supplied as part of the install rail in the installation kit)

- Before starting installation check that you have the following parts.

#### Boiling Chilled (I2CBC) and Boiling only (I2CB) models

I2CBC** models	I2CB** models	
Qty		Description
1	1	B**UC Under-counter boiler (UCB)
1	1	Instruction manual
1	-	C20UC Under-counter chiller (UCC)
1	-	3/8" push fit - equal Tee
3	2	3/8" push fit - G3/4 brass connector
1	1	Install rail & water block
3	2	1m 3/8" JG pipe
1	-	1m 1/4" JG pipe
1	-	UCB - UCC interconnect cable
1	1	IP ratings kit*
		<b>Under-counter chiller ventilation kit</b>
1	-	Air inlet grille & retaining screws
1	-	Air outlet grille & retaining screws
		<b>Filter kit (optional)</b>
1	1	FL500 filter (optional on Boiling only commercial appliances)
1	1	Filter head
2	2	1m length 3/8" blue JG flexible pipe
2	2	Filter head mounting screws
2	2	3/8" push fit elbow, to avoid tight tube bends

\*\* To identify product from its code, see explanation of product codes, page 9.

\* IP ratings kit must be fitted to prevent moisture ingress to IP31

## SECTION 6 Installing the under counter appliances

### 6.1 Positioning and ventilation - in cupboard installation



Use of tools can be hazardous, assess the risks before you start.



Use instructions supplied with individual kit parts.

- **A clearance envelope both sides and above each under counter appliance MUST be provided** to allow service access and ventilation for the safe and effective use of the appliance.



- Adequate ventilation must be provided to allow cold air to be drawn into the bottom of the cupboard, and hot air expelled from the top of the cupboard.
- **The inlet and outlet vents supplied with chilled water systems MUST be installed to keep cupboard temperatures below 30°C.**
- A minimum area of 5610mm<sup>2</sup> must be provided for the inlet vent.
- A minimum area of 9450mm<sup>2</sup> must be provided for the outlet vent.
- **4mm door buffers MUST be fitted to provide sufficient gaps for required inlet air flow.**
- Cupboard temperatures should not exceed 30°C.
- **The condenser must be facing forward & its cover on the chiller MUST be removed.**

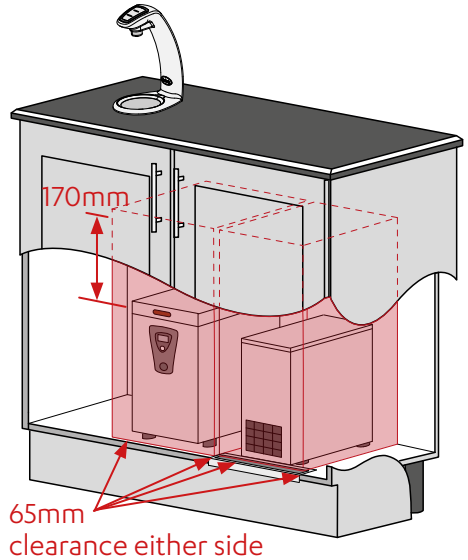

65mm clearance either side

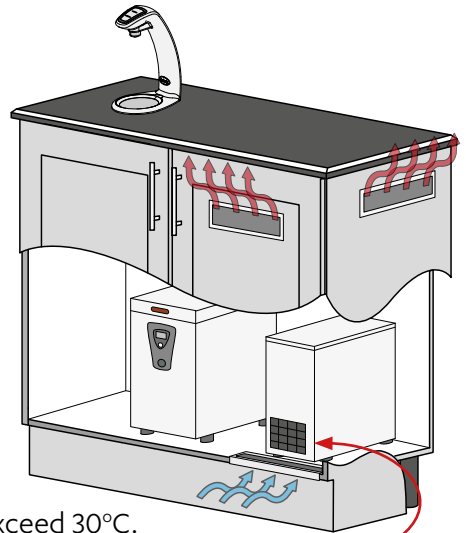

## SECTION 6 Installing the under counter appliances

### 6.2 Positioning and ventilation - under counter top installation



Use of tools can be hazardous, assess the risks before you start.



Use instructions supplied with individual kit parts.



- A clearance envelope both sides and above each under counter appliance must be provided to allow service access and ventilation for the safe and effective use of the UCB.



- Adequate ventilation must be provided to allow cold air to be drawn into the appliance, and hot air expelled from the UCB.
- Ambient air temperatures should not exceed 30°C.

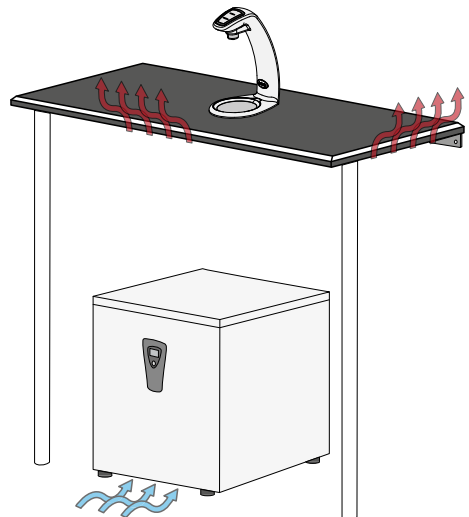
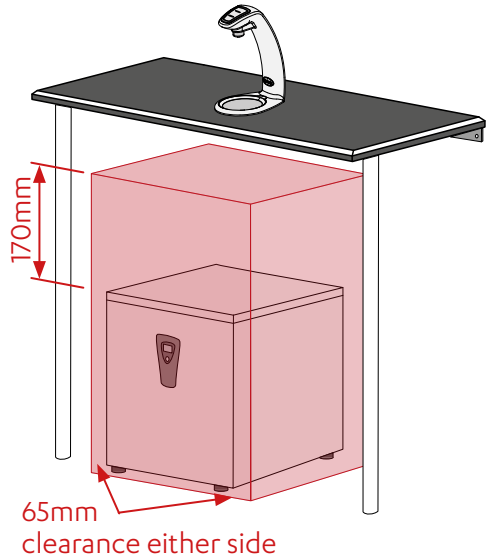

## SECTION 6 Installing the under counter appliances

### 6.3 Pipes and tubes



Install pipes & tubes correctly. No kinks, sags, pinches or loops. Ensure there is a constant fall from the tap down to the appliance.

### 6.4 I2CB10 General in cupboard arrangement

- Install the tap as close to the boiler as possible, use the illustration below as a guide, and follow the steps through this section of the manual.

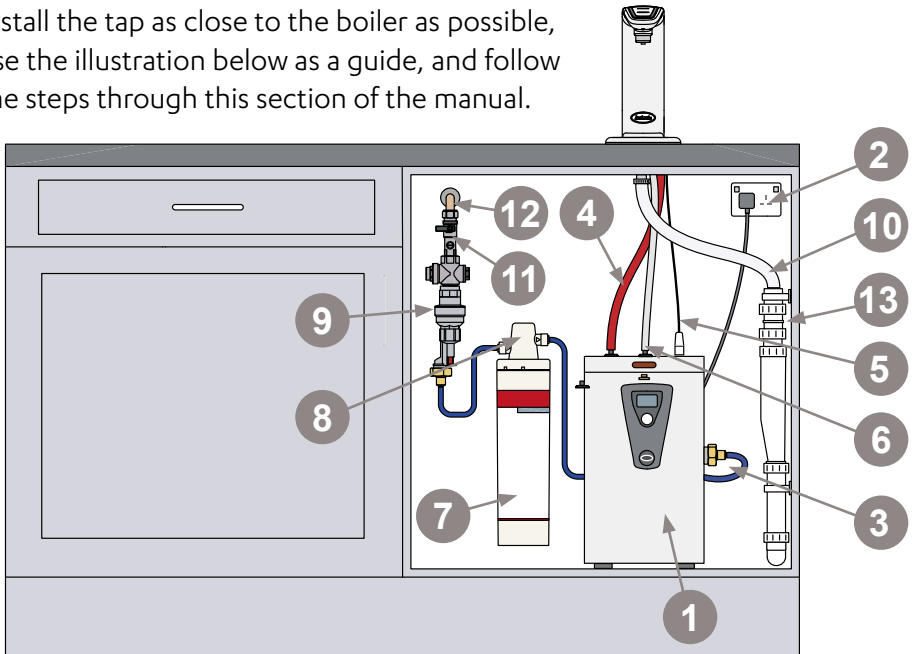

- |   |                              |    |  |
|---|------------------------------|----|--|
| 1 | Under counter boiler (UCB)   | 7  | Water filter (optional)                              |
| 2 | UCB Mains electricity supply | 8  | Filter head  |
| 3 | UCB mains water connection   | 9  | Water block  |
| 4 | UCB Boiling water tube       | 10 | Font waste pipe                                      |
| 5 | UCB Control cable            | 11 | Isolation valve (install rail inc. non return valve) |
| 6 | UCB overflow & vent tube     | 12 | Mains water supply                                   |
|   |                              | 13 | Waste to drain                                       |



## SECTION 6 Installing the under counter appliances

### 6.5 I2CBC1020 General in cupboard arrangement

- Install the under counter boiler and chiller as close to the tap as possible, use the illustration below as a guide, and follow the steps through this section of the manual.

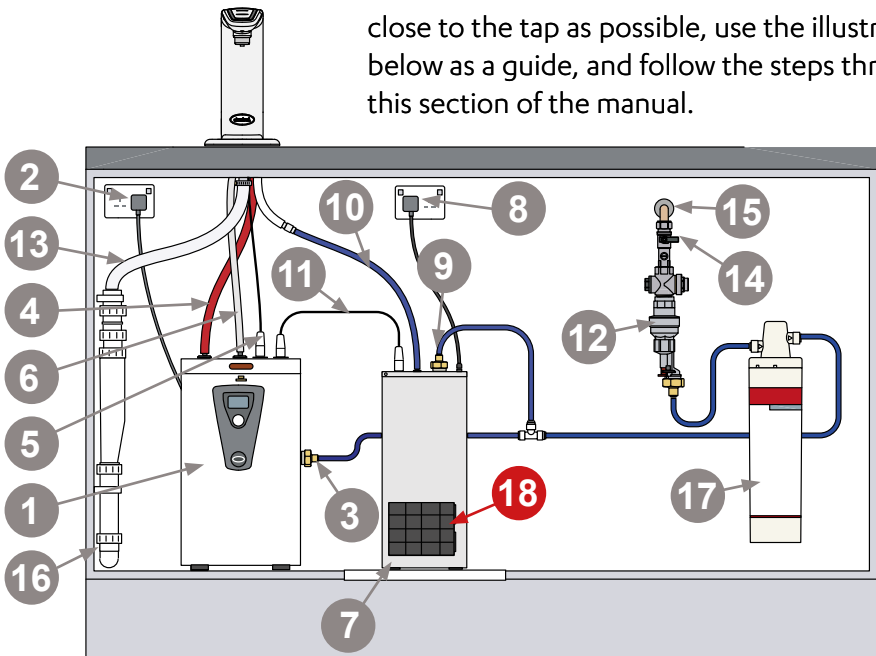

- |                                       |   |
|---------------------------------------|---|
| <b>1</b> Under counter boiler (UCB)   | <b>10</b> UCC Chilled water 3/8" pipe, connected to silicone tube |
| <b>2</b> UCB Mains electricity supply | <b>11</b> Interconnect cable                                      |
| <b>3</b> UCB mains water connection   | <b>12</b> Water block   |
| <b>4</b> UCB Boiling water tube       | <b>13</b> Font waste pipe   |
| <b>5</b> UCB control cable            | <b>14</b> Isolation valve (install rail inc. non return valve )   |
| <b>6</b> UCB overflow & vent tube     | <b>15</b> Mains water supply                                      |
| <b>7</b> Under counter chiller (UCC)  | <b>16</b> Waste to drain  |
| <b>8</b> UCC Mains electricity supply | <b>17</b> Filter & head   |
| <b>9</b> UCC mains water connection   | <b>18</b> Front facing chiller condenser (Cover MUST be removed)  |

## SECTION 6 Installing the under counter appliances

### 6.6 I2CB20 - I2CB50 General arrangement - single font model shown

- Install the under counter boiler as close to the tap as possible, use the illustration below as a guide, and follow the steps through this section of the manual.

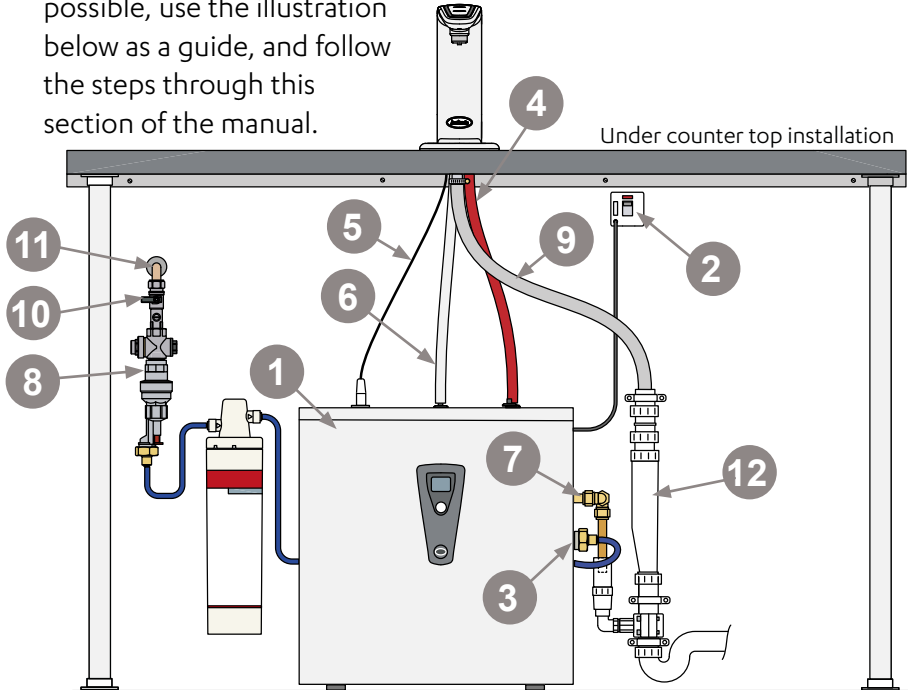

**Note** An optional filter can be installed if required.

- |   |                              |    |  |
|---|------------------------------|----|--|
| 1 | Under counter boiler (UCB)   | 7  | UCB overflow   |
| 2 | UCB Mains electricity supply | 8  | Water block  |
| 3 | UCB mains water connection   | 9  | Font waste pipe                                      |
| 4 | UCB Boiling water tube       | 10 | Isolation valve (install rail inc. non return valve) |
| 5 | UCB Control cable            | 11 | Mains water supply                                   |
| 6 | UCB vent tube                | 12 | Waste to drain                                       |

## SECTION 6 Installing the under counter appliances

### 6.7 Push fit best practice

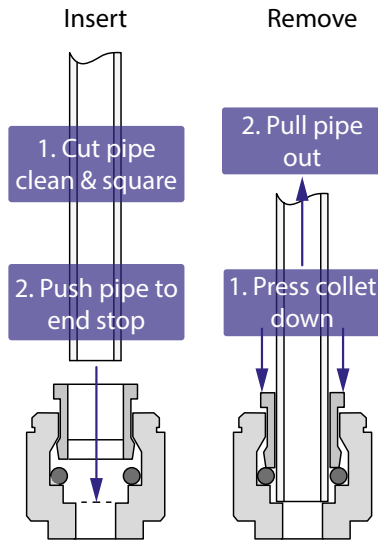

## SECTION 6 Installing the under counter appliances

### 6.8 Connect the water supply



Valves and fittings must be sealed with PTFE tape if compression seals are not included.

Water supply pressure range 0.2 - 0.5 MPa.



If the mains water pressure is below 0.2 MPa a fault could arise.

If the mains water pressure exceeds 0.5 MPa a 0.35 MPa water pressure reducing valve must be fitted. Failure to do so could result in the appliance overflowing.



To avoid damage, do not use any solder connections whilst pipes are connected to the appliance.

Instanta cannot be held responsible for any appliance malfunction if the water pressure is not within the range stated. If in doubt, consult your water supply company.



Use instructions supplied with the individual system components.

#### 6.8.1 Mains water connection

- Connect to a wholesome (cat 1) cold drinking water supply using 15mm copper pipe-work to the install rail.
- The install rail must be fitted, it includes an isolation valve to turn off the water supply for servicing or repair, as well as a back-flow prevention device to prevent water from the appliance re-entering the mains water supply.
- When installing 'push fit' fittings and pipe-work observe push fit best practice, see page 19.
- If installing the filter head, use the instructions supplied with it.
- To install and set the water block, use the instructions supplied with it and refer to page 22.
- If installing the FL500 filter, use the instructions supplied with it and refer to page 35. The filter must be flushed after installation, see page 36.
- Connect to the appliance water connection point with the 2x 3/4" - 3/8" adaptors and 3/8" flexible pipe supplied.

## SECTION 6 Installing the under counter appliances

### Mains water supply arrangement



The install rail must be fitted

#### Standard arrangement

#### Filter arrangement (optional on boiling models)

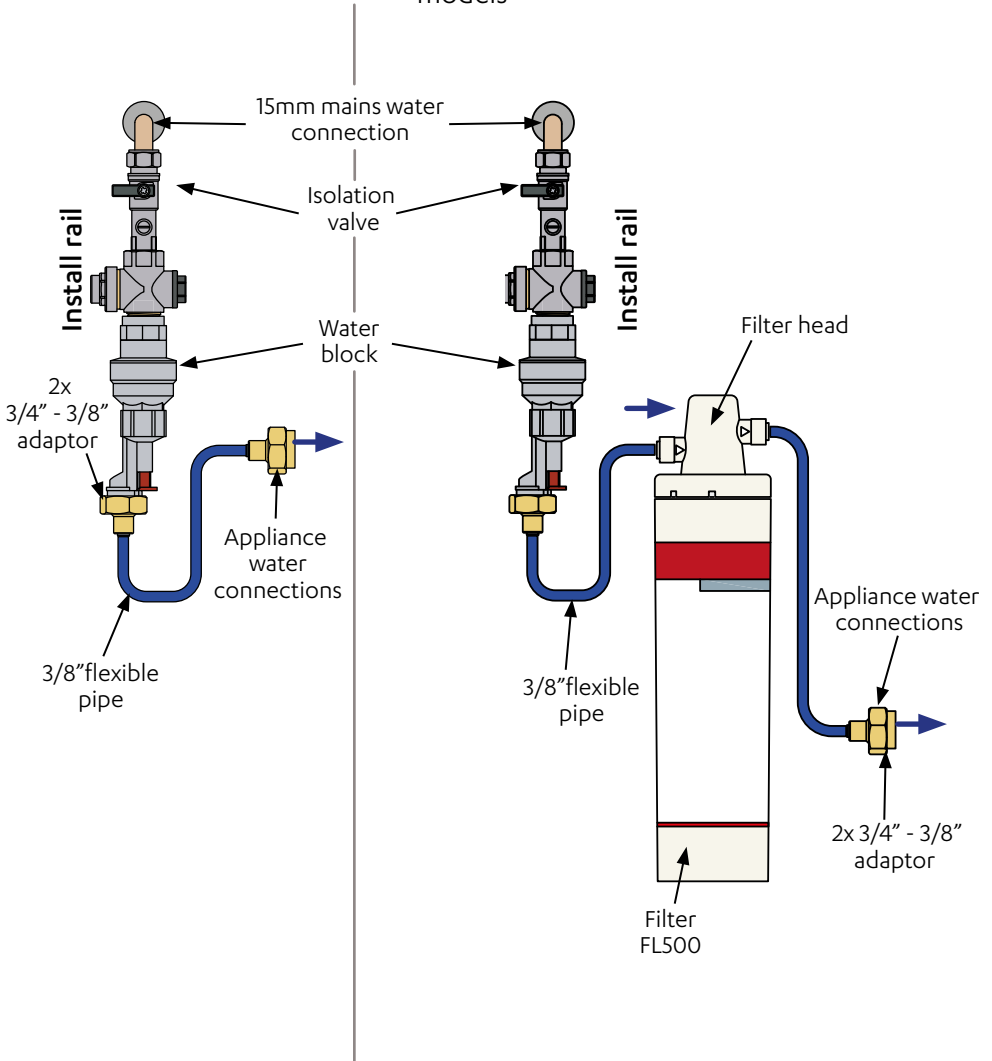

## SECTION 6 Installing the under counter appliances

### 6.9 Water block



This device must be installed vertically with the direction of flow downwards (inlet at the top, outlet at the bottom). See Fig. 1

- The Water Block should be installed in a convenient location on the water supply line to the appliance.
- Rotate Pointer 'P' (see Fig.3) until in line with the max. required flow. The number scale corresponds to 5 litres of flow i.e. 1 = 5 litres, 10 = 50 litres.
- The key (see Fig.2) should be used to adjust the pointer.
- The inlet should be connected via a 15mm copper tail.
- The outlet shall be connected via the 3/4" - 3/8" push fit brass fitting supplied.
- Ensure that the direction of flow through the Water Block is correct and that the filter screen (see Fig.2) is inserted correctly with the convex surface facing towards the water supply.

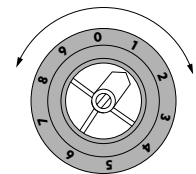
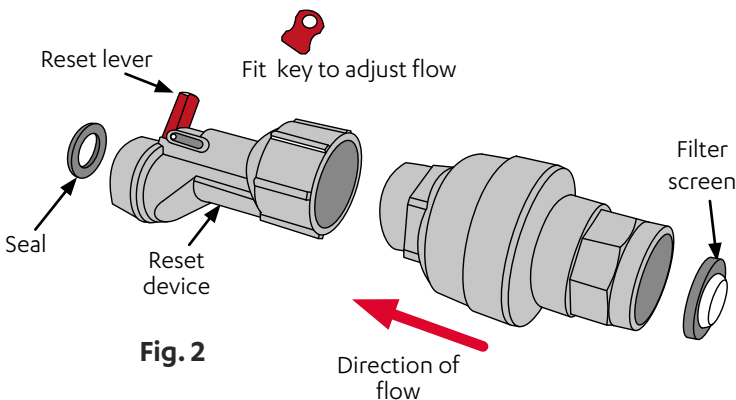
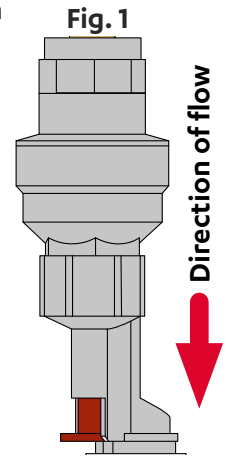

#### 6.9.1 Reset procedure

- The Water Block will activate and shut off the supply if more water than the set amount is drawn off at one time.
- In this event isolate the water supply to the Water Block.
- Identify and repair the leak then press the reset lever (Fig. 2).
- Tripping issues, contact Technical support on 0345 6 005 005 for advice.

## SECTION 6 Installing the under counter appliances

### 6.10 Manifold connections and controls

- Using the installation diagrams, see pages 14 -18 as a guide, connect the system together. (**\*Ensure IP ratings kit supplied is fitted**)

#### I2CBC1020 Boiling chilled models (top view)

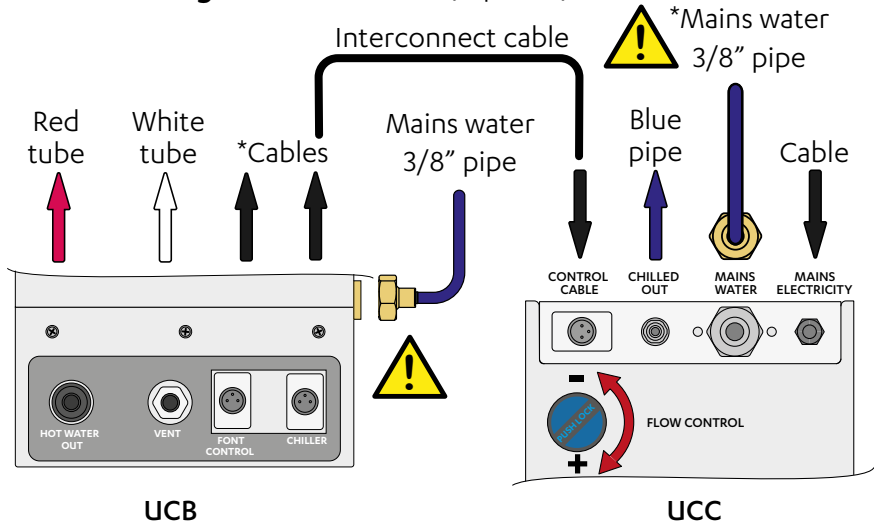

#### I2CB10 Boiling models (top view)

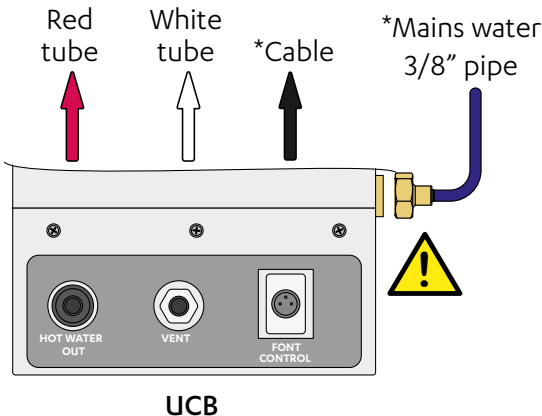

## SECTION 6 Installing the under counter appliances

### I2CB20 - I2CB50 single font models (top view)

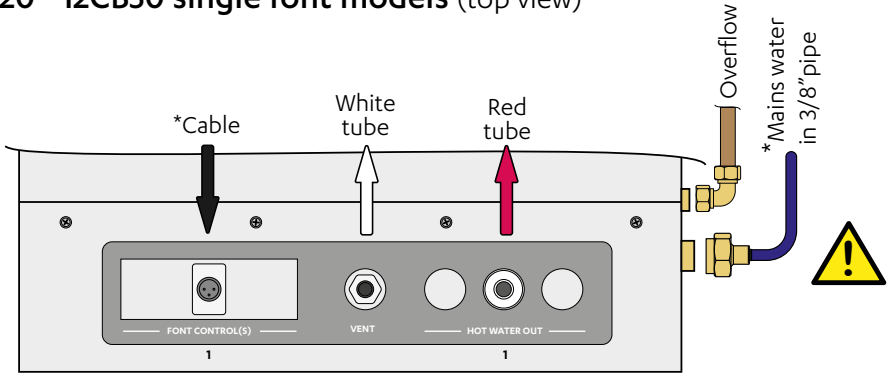

### I2CB20 - I2CB50 dual font models (top view)

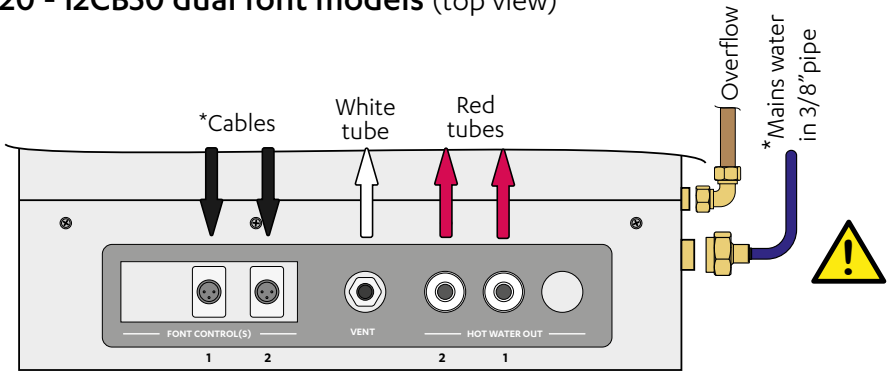

### I2CB20 - I2CB50 triple font models (top view)

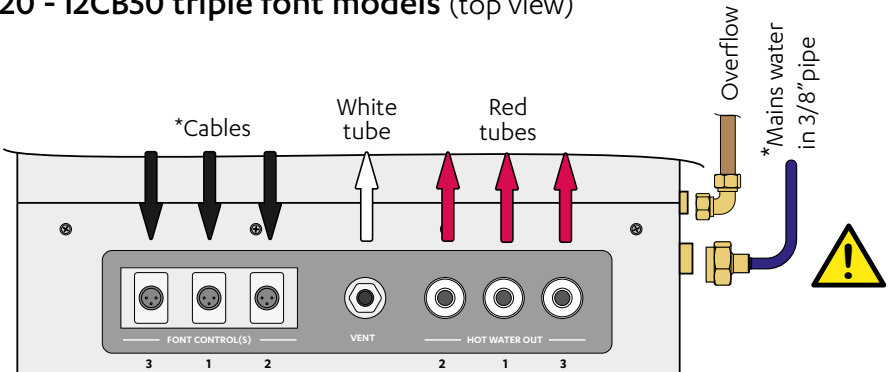



## SECTION 6 Installing the under counter appliances

### 6.11 I2CB20 - I2CB50 Overflow & drain



Instanta cannot be held responsible should damage occur from such discharge if the overflow pipe has not been directed to a suitable position where overflowing water can run away safely.

Ensure that the vent / overflow is directed to waste via a 20mm air gap.

- Connect the overflow spigot on the side of the appliance to drain with brass compression fittings.
- The overflow drain pipe must have 20mm air gap, a continuous fall and should not be longer than 300mm (if a longer run is required, use 22mm pipe to avoid airlocks).
- The overflow pipe should have no more than four right angle bends and should discharge to a safe, visible position.

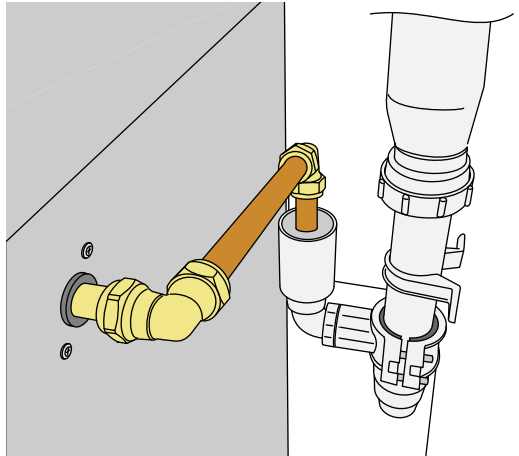

## SECTION 6 Installing the under counter appliances

### 6.12 Earth continuity test, UCB & UCC



All accessible metal parts must be earthed.

- At installation, the earth continuity of both the UCB & UCC must be checked. Use an insulation tester, appliance tester, DMM or continuity tester with an accuracy of Class 5 or better ( $\pm 5\%$  at full-scale deflection).

#### 6.12.1 To test the earth continuity

- Isolate the appliance from the electricity supply.
- Set the meter to the lowest ohms ( $\Omega$ ) scale and set to a reading of  $0\Omega$  with the meter probes connected together.
- Connect one of the meter probes to the earth wire of the mains cable or earth pin of the mains plug.
- Connect the second meter probe to a bare patch of metal or a screw (the edge is best) on the appliance and read the display.
- Repeat with the second test lead touching the metal body of the tap.
- All readings should be less than  $1\Omega$ .
- If any of the reading are above this value, check the earth connection inside the appliance.

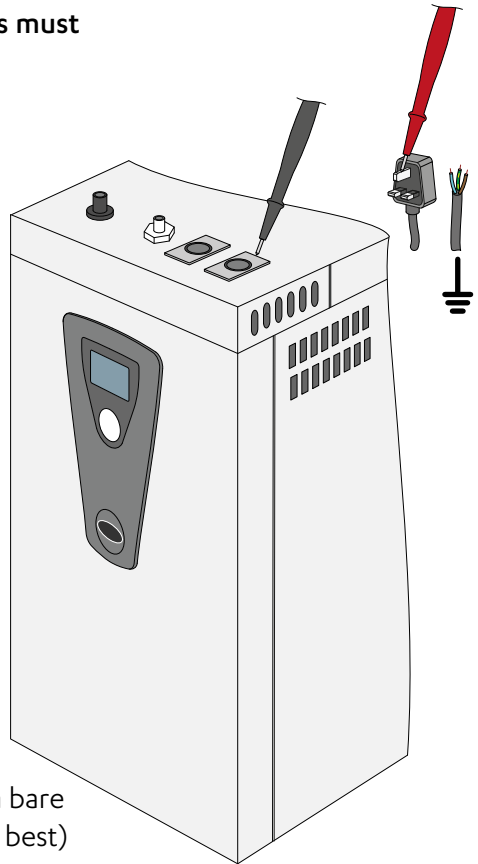

Insulation resistance meter or DMM

## SECTION 6 Installing the under counter appliances

### 6.13 Connect the electricity supply



Before you start read :  
Section 2 Important safety instructions.  
Section 3 Warnings & Regulatory information.

Do not switch on the mains electricity supply until installation is complete and all electrical /plumbing connections have been made.

#### I2CBC1020, I2CB10 models

- Connect the mains plug to a 230V 50Hz 13A socket.

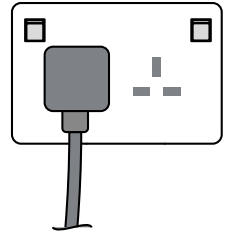

#### Mains cable wiring I2CB20 - I2CB40 models

- Appliances rated to up to 3 KW must be connected to a 20A isolator fitted with a suitable ELCB.
- The mains cable is supplied ready fitted to the appliance.
- Mains cable size, 2.5mm<sup>2</sup>.
- Electrical installation should conform to current IEEE wiring regulations.

#### I2CB50 - 4.5kW models

- Appliances rated to 4.5kW must be connected to a 20A isolator fitted with a suitable ELCB.
- The mains cable is supplied ready fitted to the appliance.
- Mains cable size, 4.0mm<sup>2</sup>.
- Electrical installation should conform to current IEEE wiring regulations.

#### I2CB50 - 6.75kW models

- Appliances rated to 6.75 kW must be connected to a 30A isolator fitted with a suitable ELCB.
- The mains cable is supplied ready fitted to the appliance.
- Mains cable size, 4.0mm<sup>2</sup>.
- Electrical installation should conform to current IEEE wiring regulations.

### 7.1 At first switch on



#### Santising

- All InstaTap models with chilled functionality must be sanitised during installation or the commissioning process.
- Please contact us on 0345 6 005 005 to book a commissioning service.

#### 7.1.1 B\*\*UC Under counter boilers

- Flush the filter, see page 36.
- Turn on the mains water supply.
- Switch on the mains electricity supply.  
In a Boiling chilled system, always switch the UCB on first, then the UCC, as the UBC controls the UCC.
- Switch on the UCB by pressing the ON/OFF button on the display panel.
- The system runs through an initial self diagnostic check, various messages are displayed on the screen.
- The appliance begins to fill with water.
- NOT READY, FILLING, --°C" is displayed.
- If the tank does not fill to its pre-set level within :  
**B40UC & B50UC models** : 10 minutes.  
**All other models:** 6 minutes.
- CHECK WATER is displayed.
- If this happens, check that the isolation valve is turned on, there are no kinks in the inlet hose and that the Water Block doesn't need to be reset.
- If these are in order, check that the filters in the Water Block and water connection point are not clogged with debris.
- To clear the warning, switch off the UCB mains

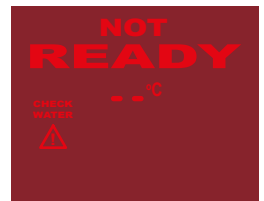
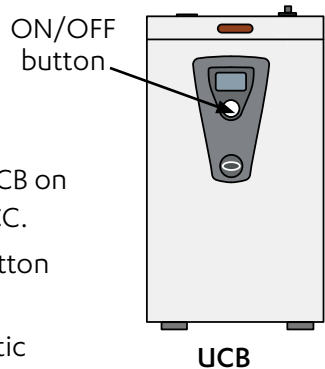

## SECTION 7 Commissioning

electricity supply, and then switch back on.

- When the water level reaches the boiler's bottom sensor, the heater is switched on.
- NOT READY, HEATING, --°C is displayed.
- When the water temp is close to the programmed temperature , the real time temperature is displayed.
- When the programmed temperature has been reached, READY, CAUTION HOT WATER, (TEMP)°C is displayed.
- The red background illumination is extinguished.
- The tap controls illuminate.

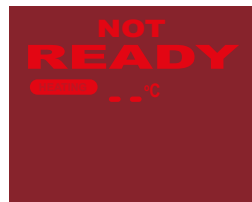

- The UCB does not fill completely at once. The water input is electronically controlled to obtain maximum output, temperature and efficiency.
- Dispense (see page 32) 3 litres of water to flush the UCB system.
- Wait again for the screen to read READY before making a drink.



**IMPORTANT NOTE** In daily use you may use the appliance as soon as the tap controls illuminate but on first installation wait at least 10 minutes before starting to use the water.

### 7.1.2 C20UC Under counter chiller (UCC)

- Flush the filter, see page 36.
- Turn on the mains water supply.
- Switch on the mains electricity supply.
- Using the chilled water button on the tap control panel, (see page 33) dispense 3 litres of water to prime and flush the UCC system.
- Wait 30 minutes , the fan and compressor will turn off indicating that the UCC has reached its normal operating temperature and is ready for use.

## 8.1 Tap controls

### Warning symbol

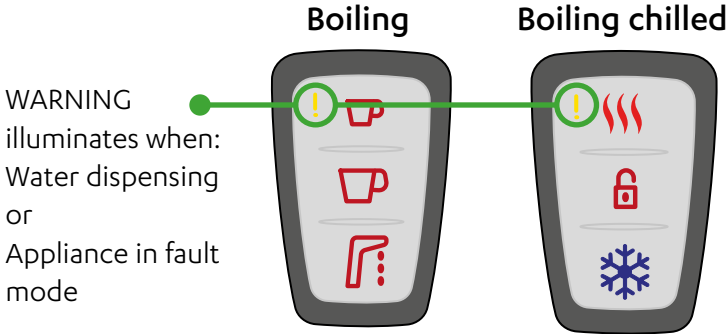

- The exclamation mark on tap flashes when in fault mode, at the same time warning triangle flashes on the UCB display screen.

### Dispense controls

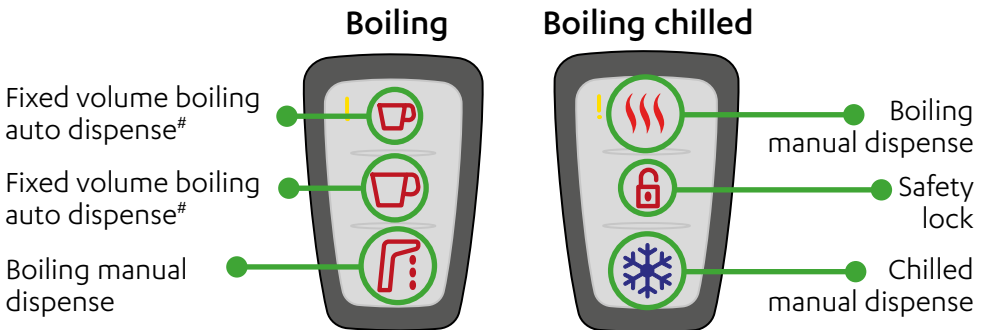

- To set fixed volume dispense, see page 34.

## SECTION 8 Operation

### 8.2 Safety lock (boiling chilled models only)

- The safety lock is enabled by default.
- The safety lock is a boiling water feature only, and does not need to be disabled when dispensing chilled water.

• When the safety lock is enabled :

• Exclamation mark is extinguished. ●

• Safety lock is illuminated. ●

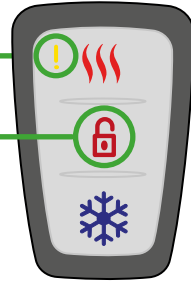

• To disable the safety lock :

• Press safety lock. ●

• All icons illuminate.

• The safety lock is disabled.

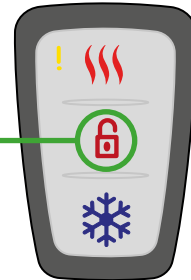

• Press any boiling water dispense button (within 5 seconds of disabling the safety lock) to dispense water. ●

• Following dispense, the safety lock automatically re-enables.

• Safety lock illuminates.



### 8.3 To dispense boiling water



- Make sure the InstaTap is switched on and ready to use, see page 28.
- Familiarise yourself with the tap control icons, see pages 30-31.
- Check that the tap control safety lock icon is illuminated, see page 31.
- To manually dispense boiling water, place cup on drip-tray.
- Press the safety lock.

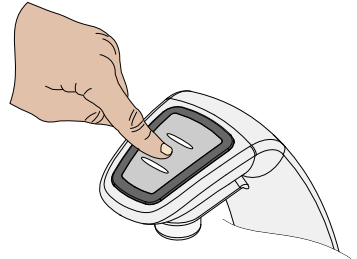

- Press the chosen icon to dispense.
- CAUTION HOT WATER flashes on the UCB display screen during boiling water dispense.

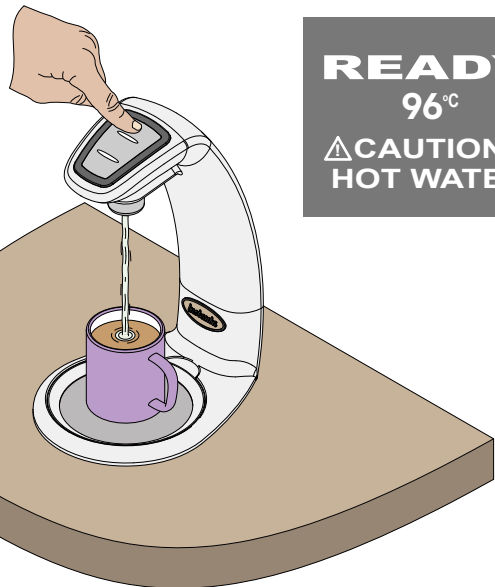



### 8.4 Dispense chilled water

- Make sure the InstaTap is switched on and ready to use, see page 28.
- Familiarise yourself with the tap control icons, see pages 30 - 31.
- To manually dispense chilled water, place glass or jug on front.
- Press the chilled icon to dispense.

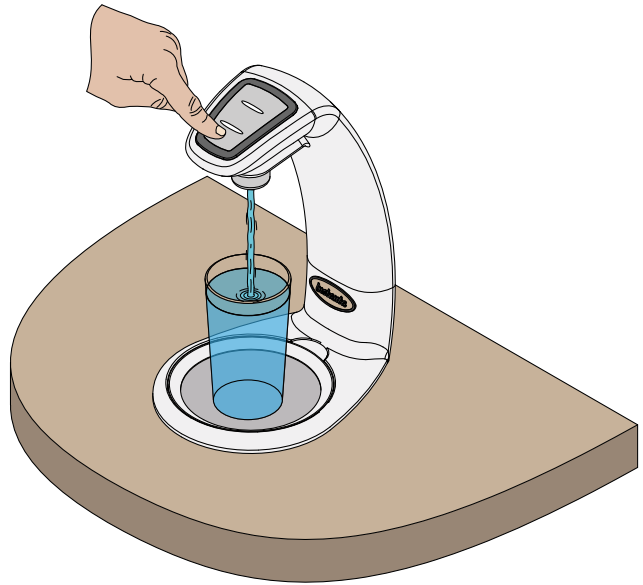

### 8.5 Adjust the chilled water flow rate from the UCC

- The chilled water flow rate have been factory set, however on-site adjustment may be necessary. The water flow-rate adjustment knob is on the top of the UCC, see page 23.
- To adjust, pull flow-rate adjustment knob upwards.
- Turn clockwise to increase, anti-clockwise to reduce.
- As a guide, a small glass (180ml) should take approximately 5 seconds to dispense.
- **Note** If the flow-rate is faster than this, water passes through the cooling block too quickly and dispensed water may not be as cool as specified.

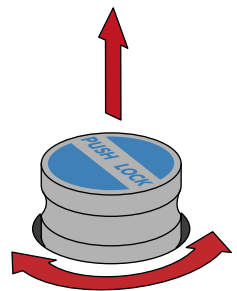

### 8.6 Set up the fixed volume dispense



#### Not available on I2BC1020 Boiling & Chilled models

- This function is useful when the cup/teapot being filled is always the same size/capacity.
- **IMPORTANT: Before setting up fixed volume dispense, wait until appliance is 'Ready' and tank is at full capacity.**
- To change from on-demand dispense (default) to set volume dispense :
  - Switch off under counter boiler using ON/OFF button.
  - Switch OFF mains power supply and wait 10 seconds.
  - **For I2CB10, I2CB20 models:** Switch back ON and at the same time, press the bottom dispense button (on the tap) within 5 seconds.
  - **For I2CB40 & I2CB50 models:** Switch back ON and within 5 seconds, press the ON/OFF button on the front of UCB.
- The tank will either start to fill with water or the dispense button will begin to flash (depending on water level in tank).
- Screen flashes alternate red white
- Release the ON/OFF button.
- The display will show the ready screen (unless tank is filling).
- Press the relevant fixed volume dispense button, & hold until filled with the desired volume).
- Don't take finger off, until desired volume is dispensed.
- Press the bottom dispense button to save the measured volume (the appliance will switch OFF).
- Switch the appliance on again using the ON/OFF button on the front panel of the UCB.
- The set volume has now been programmed.

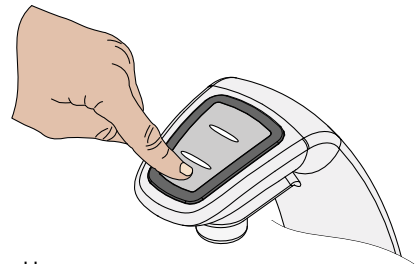
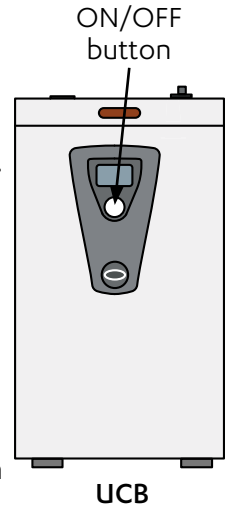

## SECTION 9 Maintenance

### 9.1 Replace ,flush and reset the filter



Not changing the filter cartridge when required may affect the water quality.

Sanitisation should be carried out at all filter changes, or at intervals of no more than 12 months.



Use instructions supplied with the filter cartridge.

#### 9.1.1 Replace the FL500 filter

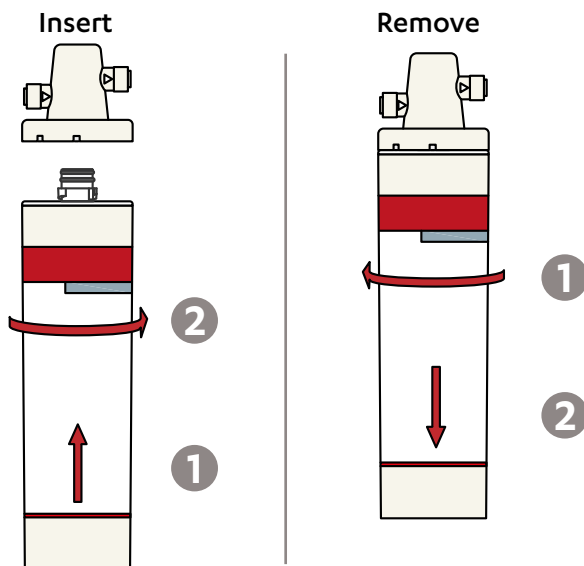

- Turn OFF the power supply to the (UCB) and (UCC) appliances.
- Turn OFF the isolation valve on the install rail.
- Remove the old filter (see above).
- Be aware that some water may drip from the filter head.
- Remove the sanitary cap from the new filter, do not touch the connector .
- Moisten the new filter connector with clean tap water.
- Insert the new filter (see above).
- Flush the filter, see page 36.
- Turn ON the power supply to the (UCB) and (UCC) appliances.
- Reset the filter monitor, see pages 38.

## SECTION 9 Maintenance

### 9.1.2 Flush the filter

- Turn OFF the power supply to the under counter appliances.
- Turn OFF the water supply to the under counter appliances with the isolation valve on the install rail.
- Disconnect the water supply hose to one of the under counter appliances.
- Direct the water supply hose into a sink or suitable container.

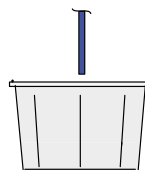
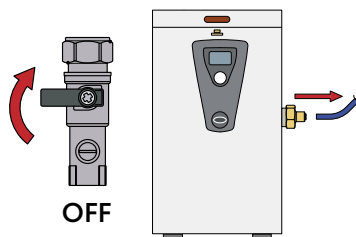

- Turn ON the isolation valve on the install rail.
- Flush the new filter with the volume of water stated in the instructions supplied with the filter - usually a minimum of 10 litres.
- Be aware, depending on the water block setting, it may trip and need to be reset during the flushing process, see page 22.

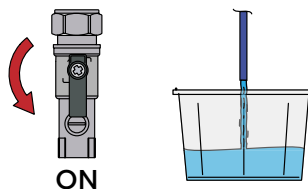

- Turn OFF the isolation valve.
- Reconnect the mains supply hose to the under counter appliance.

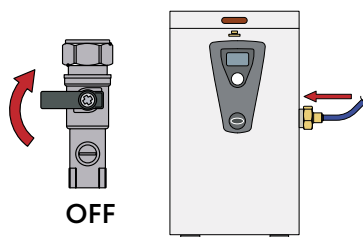

- Turn ON the water supply to the under counter appliances with the isolation valve.
- Turn ON the power supply to the under counter appliances.

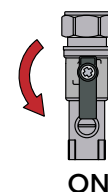

### 9.1.3 UCB filter monitor settings

- The under counter boiler has different settings for SOFT, MEDIUM & HARD water conditions.
- The filter monitor is factory-set to MEDIUM which is suitable for most parts of the UK with average or medium water hardness.
- The effectiveness of the filter will be reduced in hard water areas (and should be replaced more frequently), or extended in soft water areas where limescale is less of a problem.
- If in doubt as to the hardness of water supplied in your area, consult your local water authority or call Technical Support on 0345 6 005 005.

### 9.1.4 Adjust the UCB boiling water temperature

- The temperature of water in the tank can also be adjusted during the same procedure as the filter monitor.
- Turn off the under counter boiler with the ON/OFF button above the display screen.
- Press & hold ON/OFF button (approx. 12 seconds).
- The display screen shows the Pr icon.
- Release the ON/OFF button.

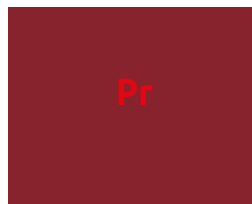
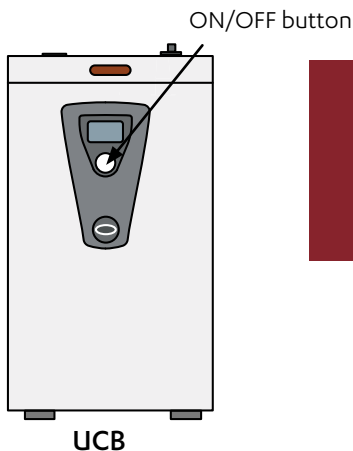

### 9.1.5 Set the temperature

- After releasing the ON/OFF button (above the temperature setting is displayed).
- Press ON/OFF button incrementally to adjust the temperature by 1°C per increment.
- The adjustment will increase the temperature, to set a lower temperature, continue to cycle through the range.

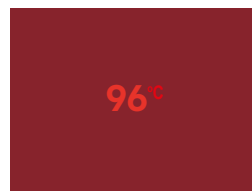

### 9.1.6 Set the filter monitor

- The filter monitor on the under counter boiler can be changed from the default MEDIUM setting to HARD or SOFT setting as follows:
- Replace and flush the filter, see pages 35-36.
- Continuing on from the temperature setting screen.
- Press & hold button (long push) for approximately 5 seconds until screen changes to show MEDIUM (default filter setting).
- Press button (short push) to scroll between the different filter settings.
- SOFT
- MEDIUM
- HARD
- EMPTY FILTER  (no filter monitor).

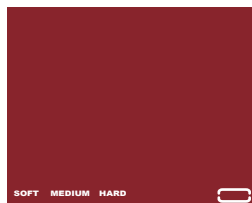
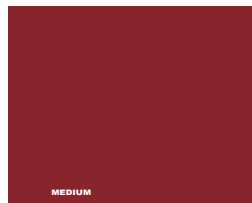

- With the required filter setting selected, press & hold ON/OFF button (long push) for 4 seconds to save.
- Press & hold ON/OFF button (long push) for approximately 6 seconds until display goes blank.
- Press ON/OFF button to turn the UCB5 back on again.

### 9.2 Cleaning



Cleaning of the tap and dispensing outlets must only be undertaken with alcohol or sanitising wipes. Chemicals should NOT be sprayed onto the Tap or under counter appliances at any time.

Never use strong, corrosive or abrasive cleaning materials on the InstaTap Tap or under counter appliances.

This could cause permanent malfunction and void warranty.

- Clean tap, font, under-counter appliance and ancillaries at 30 day intervals, or sooner if required.
- Wipe surfaces with a sanitising wipe and leave to air dry.

#### 9.2.1 Cleaning the aerator



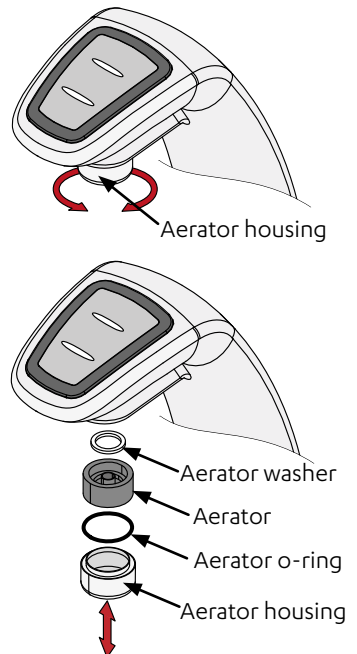

- Clean the aerator at 30 day intervals, or earlier if contamination occurs.
- To clean the aerator, unscrew the aerator housing clockwise, and remove.
- Disassemble the components.
- Clean all components with warm soapy water.
- Rinse with clean water.
- Reassemble, and screw the assembly clockwise back in place.



## SECTION 10 Service warnings and troubleshooting

### 10.1 Troubleshooting

- The UCB is fitted with an intelligent fault diagnosing system and is able to detect various fault conditions. Some of these are less serious and it will continue to operate as normal, while others are more serious and will cause the UCB to be disabled.

	Non functional warnings	Possible causes	Action
		Water turned off. Inlet hose kinked or bent. Low in-coming water pressure.	Check water supply and isolation valve Check in-coming water is at minimum of 0.2 MPa.
		Low-water level probe scaled up.	Call us on 0345 6 005 005 or use the instructions in the 'Instanta service manual' to de-scale inside of tank and level sensors.
		Normal operating probe scaled up.	Call us on 0345 6 005 005 or use the instructions in the 'Instanta service manual' to de-scale level sensors.
Flashing		Over-boiled (due to excessive lime-scale in tank). Faulty Element. Thermistor disconnected, wires cut or faulty. Boil-dry safety switch tripped or faulty.	Call us on 0345 6 005 005 or use the instructions in the 'Instanta service manual' to de-scale level sensors.  Isolate machine and wait 10mins, then turn back on again. Reduce temperature setting. Call us if fault persists.
Flashing		Thermistor disconnected, wires cut or faulty.	Call us on 0345 6 005 005.

- Before calling for service, switch the UCB off at the mains supply and then switch back on after 10 minutes. If the fault does not clear, call technical support for advice on 0345 6 005 005.



### 10.2 In case for accidental freezing



Before you start read :

**Section 2 Important safety instructions.**

**Section 3 Warnings & Regulatory information.**

- Ensure that ambient environmental conditions around the appliance are above the minimum operating temperature of the appliance.
- Turn off the electricity and water supplies for 12 hours to allow the appliance to defrost, then turn back on.

### Waste electrical and electronic equipment

- The symbol above means that according to United Kingdom and European Union member countries laws and regulations, your product and/ or its battery shall be disposed of separately from household waste.
- When this product reaches its end of life, take it to a collection point designated by local authorities. The separate collection and recycling of your product and/ or its battery at the time of disposal will help conserve natural resources and ensure that it is recycled in a manner that protects human health and the environment.

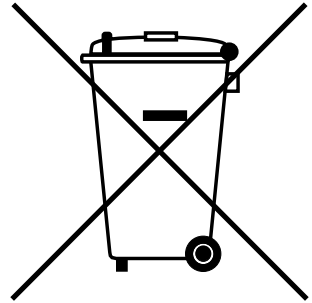

### Warranty

- The appliance is guaranteed for two years from date of installation.
- Our guarantee includes on site labour and parts for problems caused by fault of manufacture and component failure with the following exclusions:
- Problems caused by hard water and limescale. We regret that we cannot be held responsible for problems caused by hard water.
- Accidental damage, misuse or use not in accordance with these instructions and damage caused by incorrect installation.
- The manufacturer disclaims any liability for incidental, or consequential damages.
- For more information please refer to the online [Instanta Warranty Policy](#).



**Zip Water UK**  
**Instanta**  
Trafalgar House,  
Rash's Green, Dereham,  
Norfolk, NR19 1JG  
0345 6 005 005

[www.zipwater.co.uk](http://www.zipwater.co.uk)  
[www.instanta.com](http://www.instanta.com)

