

**INSTRUCTIONS FOR INSTALLATION AND USE  
WALL WARMING SALAD'BAR  
SBM 40 C**



**Made in France**

# WALL WARMING SALAD'BAR SBM 40 C

Congratulations for the acquisition of this upmarket appliance made in France. You chose an appliance which alloys the best technical qualities with a big user-friendliness. We wish you the biggest contentment

## 1. SECURITY INSTRUCTIONS

Please respect these instructions scrupulously to avoid any risk of fire, electric shock, scald or other wounds and damage. During the use of this appliance, fundamental circumspection of security must always be noticed, such as:

- Take into account the instructions to be systematically kept with the appliance.
- Install the appliance always in instructions respect. A 10 cm distance minimum with the partition or the wall is necessary.
- Protect the appliance from direct light of the sun, frost and humidity.
- Never leave the appliance within the reach of children or disabled persons without surveillance.
- The machine has to be used only by qualified person.
- Never move the appliance when it is working.
- Check that the appliance is definitely off before connecting it up or disconnecting it.
- Do not touch the hot surfaces of the appliance. The temperature of the hot surfaces can be very important when the appliance is working. Always use handles and control knobs.
- Do not use the appliance for other functions than determined use.
- Do not leave the electrical cord in contact of hot surfaces.
- The appliance should not be used close to combustible materials.
- During use, look after not to obstruct hearings of aeration of the appliance
- To avoid any electric shock, never plunge the cord or plug in water or quite other liquid.
- If the cord is harmed, it must be replaced by the producer, its after sale service or persons of similar skills to avoid any risk.
- Entrust repairs only to a skilled person.
- Use only spare parts of origin.
- Before cleaning the appliance, do not forget to disconnect it.

## 2. CONTENTS OF CARDBOARD PACKAGING

Device: a salad'bar

- Accessories:
- Two castors without brake + two castors with brake
  - A light reflector
  - A left upright and a right upright
  - Two stainless steel protections
  - Screws
  - A mirror
  - The present note

See exploded view at the end of the document

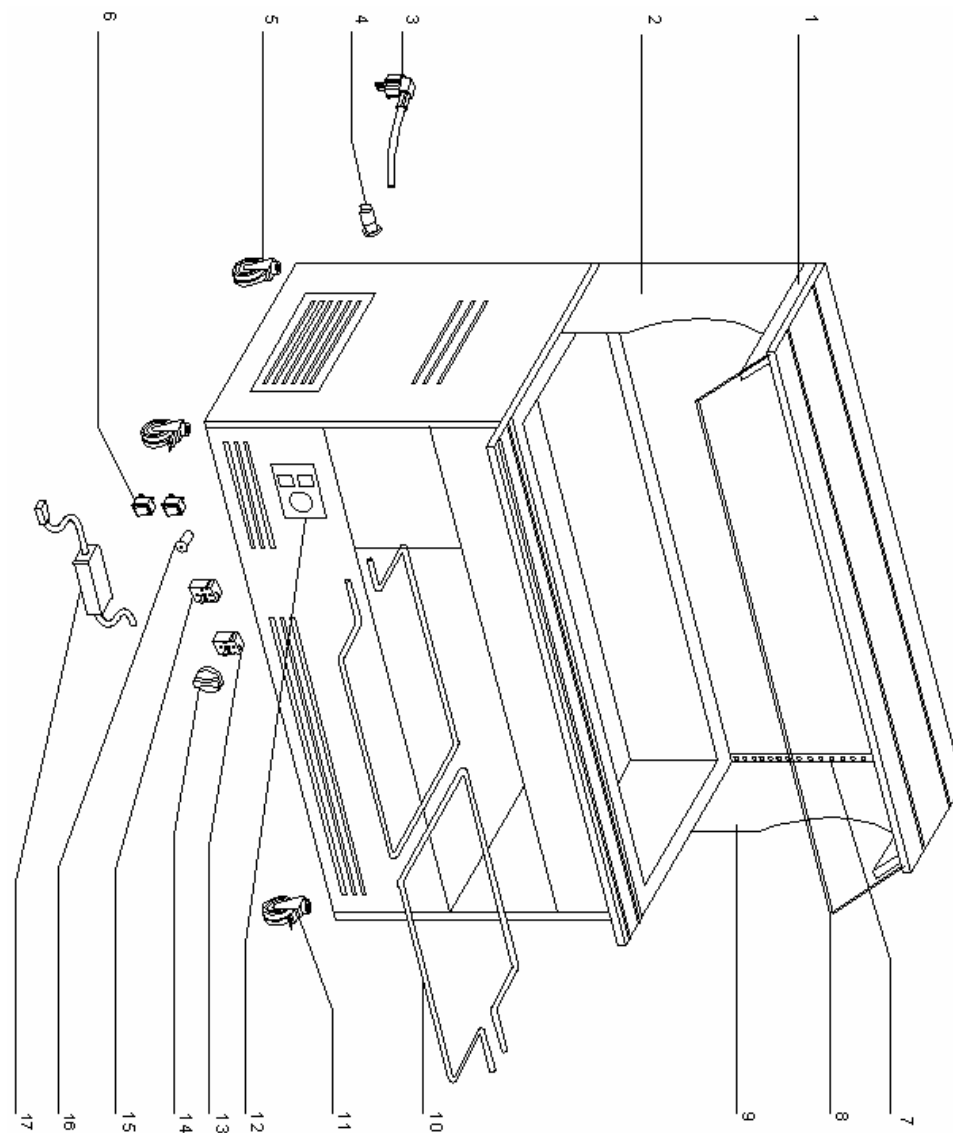

Nomenclature **SALAD'BAR MURAL CHAUD**  
Spare parts **WALL WARMING SALAD'BAR**

Rep	Code	Qty	Pièce	Spare part
1	77047	1	Toit inox	S/steel roof
2	77050SE	1	Montant gauche	Left upright
3	C03007	1	Cordon + prise	Cord with plug
4	A10001	1	Serre cable	Cord closer
5	SF08019	2	Roue sans frein	Wheel without brake
6	A07025	2	Interrupteur	Switch
7	SA18035	1	Led	Led
8	SH01103	1	Plexiglas	Plexiglass
9	77051SE	1	Montant droit	Right upright
10	SD02107	2	Résistance	Heating element
11	SF08018	2	Roue avec frein	Wheel with brake
12	77027SE	1	Tableau composant	Control panel holder
13	SA06051	1	Thermostat sécurité	Safety thermostat
14	A14093	1	Bouton	Knob
15	SA06050	1	Thermostat	Thermostat
16	A08009	1	Voyant vert	Green pilot light
17	SA03093	1	Alimentation led	Led alimentation

### 3. CONFORMITY OF USE

Use the salad'bar only to keep warm your hot starters, meat, vegetables, readymade dishes...at a temperature between +20°C and +90°C during working and service hours. It enables you keeping warm products already cooked or hot

### 4. WAY OF FUNCTIONING

These salad'bars exist in 4 versions : SBM 40 F, SBM 40 C, SBM 40 N, SBM 40 M. They respectively keep the GN containers cold, warm or at the ambient temperature or 2 warm containers / 2 cold containers.

To turn on your salad'bar, press on the switch (n°2 on picture): the green pilot light (n°4 on picture) ignites. Turn on the thermostat control knob (n°3 on picture) on the desired temperature.

Press on the upper switch (n°1 on picture) to turn on the light (n°5 on picture). Once water is hot, you can place the GN containers.



1 Lighting switch

2 On/off switch

3 Thermostat

4 On/off pilot light

5 Light

6 Mirror

## **5. FUNCTIONING / MANIPULATION**

### **a) Installation / assembly:**

- Unpack carefully the appliance from its packaging
- Place the equipment on a stable and heatproof surface.
- Never place the device near a wall or near a partition made of combustible materials even if it is very well isolated.
- A distance of 10 cm from the partition or the wall is considered enough.
- Remove the protective film from the appliance.
- Position the accessories (see 11. Installation guide)

### **b) First starting:**

Fill the container with water (about 5 cm above the heating elements) before switching on the salad'bar.

Do not let it run without water : it could damage the heating elements and irremediably bend the container.

To avoid quick evaporation, cover the whole tank with containers or lids.

### ***First cleaning***

Clean the device before the first use. (See 6 Cleaning)

### ***Connection of the device***

- Check that the tension and the frequency of the electricity network suit to the values indicated on the descriptive plate.
- Check that neither the cord nor the plug are damaged
- Make sure that every control knob is positioned on 0.
- Unwind completely the electric power cable and connect it in a normalised plug with the earth.
- The device is connected.

**NB:** in case of connection of the device in a plug without earth protection or directly on the electricity network, confide its connection to a qualified person .

## **6. Connection**

Connect every wire. ( Picture M)

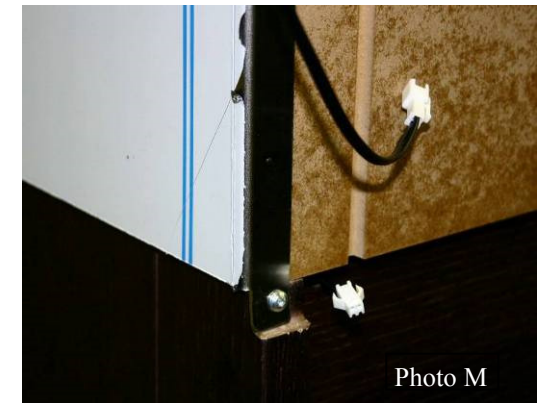

Photo M

## **7. Fix the protection for wires**

Fix the stainless steel protection for wires with the screws B (Picture F on page 2 + Picture N)



Photo N

## **8. Final fixation of the mirror**

Insert both screws C on the back top of the uprights (Picture F on page 2 + Picture O)

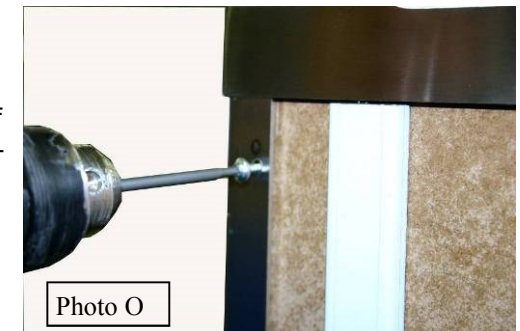

Photo O

Your salad'bar is ready. You can place it and plug in with normalized 220-240 V ~ according to the instructions manual.

Unscrew the protective screw, put the mirror in the slide of the upright and fix again the screw as well as the back screw B (Picture F on page 2).

Attention: Both wires should be outside (Picture I)

At this stage, the mirror is at its place but must be hold.

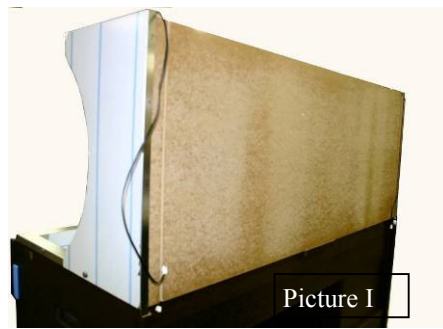

Picture I

## 5. Mounting of the top parts

### A. Mounting of the roof

Remove the protective film from the roof and put the roof on both uprights. (Picture J)



Picture J

### B. Mounting of the top shelf

Place the shelf on the roof with both plastic shaped parts up. (Picture K)

Fix the screws A (Picture F on page 2).

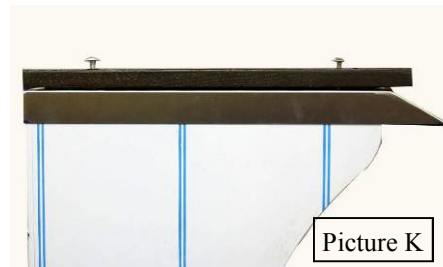

Picture K

### C. Mounting of the plexiglas

Remove the protective film.

Place the plexiglas under the stainless steel roof (Picture L) and fix the screws D (Picture F on page 2).

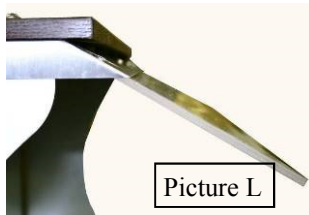

Picture L

## c) Use of device :

### Elements of command and display

Command/Display	Function
Thermostat (n°3 on picture)	Temperature setting
Switch 0/I (n°1 on picture)	Light on / Light off
Switch 0/I (n°2 on picture)	On/off
Green pilot light (n°4 on picture)	Machine on (pilot light on) Machine off (pilot light off)

### Starting

- Press on the switch (n°2 on picture), the green pilot light (n°4 on picture) ignites.
- Turn on the thermostat (n°3 on picture) on the desired position.
- Press on the switch (n°1 on picture) to turn on light.

### Temperature setting

- Set the temperature by positioning the thermostat (n°3 on picture) to the desired temperature.

### Stopping the appliance

- Set each switch (n°1 and 2 on picture) on 0: the appliance is no longer functioning.
- Disconnect the power cable.
- Clean the appliance. (see 6. Cleaning)

## d) Breakdown / repair:

In case of breakdown or of damaged part, please call your after-sales service and confide any technical operation to qualified person.

When you contact the after-sales service of your distributor or your store, give him the complete reference of your device (commercial name, type and serial number). This information appears on the visible descriptive plate behind the device.

## 6. CLEANING AND MAINTENANCE

Disconnect the device.

- Let cool completely the device before any technical intervention or cleaning.

- Clean regularly the metallic parts after each use by using only use non-abrasive products, warm water and wash liquid: avoid the abrasive towelling. Rinse your device with a wet sponge and dry it with a soft cloth.
- Never clean the device under a water jet, the infiltrations would risk to damage it in a irreparable way.
- Never immerse the cord or the plug in the water or quite other liquid to avoid any electric shock.
- Regularly change the water to avoid any scale deposit.
- Never use abrasive product or vinegar, it could damage the container in ir-remediable way.

## 7. TECHNICAL SPECIFICATIONS

Model	SBM 40 C
Dimensions	1495x855x1405 mm
Weight	100 Kg
Power	+20° à +90° C
Gas	3600 W
Temperature	2
Current	15.5 A
Voltage	220-240 V ~
Colours	Wenge/Light oak / Mahogany

Wires colours correspondance

Phase  
Neutral  
Earth

Brown / Black / Grey  
Blue  
Yellow-Green

## 8. NORMS AND LEGALS DISPOSALS

The device is conform to :

- IEC/EN 60335-1
- IEC/EN 60335-2-49
- EN 55014-1 + 55014-2
- EN 61000-3-2 + 61000-3-3

## 9. ELIMINATION OF THE ELECTRIC AND ELECTRONIC WASTE

The device respects the directives:

- 2002/ 96/CE ( DEEE) N°34270064800021
- 2002/ 95/CE ( ROHS)
- 2066/95 CE
- 2004/108 CE



B. Unscrew the protective screw on the container (Picture D) and fix the left upright with the screw. (Picture E)

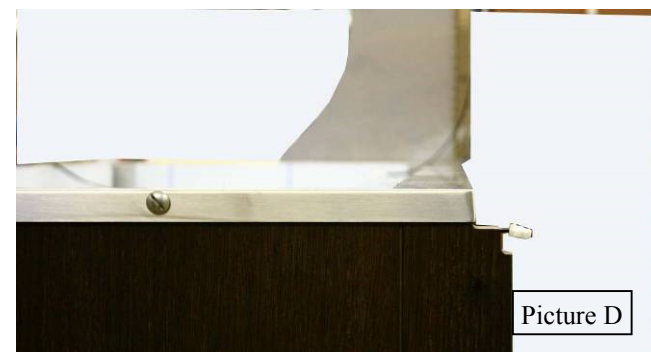

Picture D

C. Fix the screw B (Picture F) behind the left upright (Picture E).

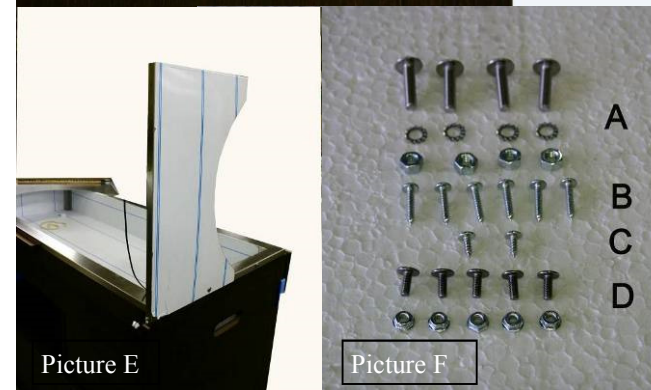

Picture E

Picture F

### Mounting of mirror

The mirror must be taken by 2 persons and be put along the slide on the left upright. One person must support it in its position. .(Picture G)

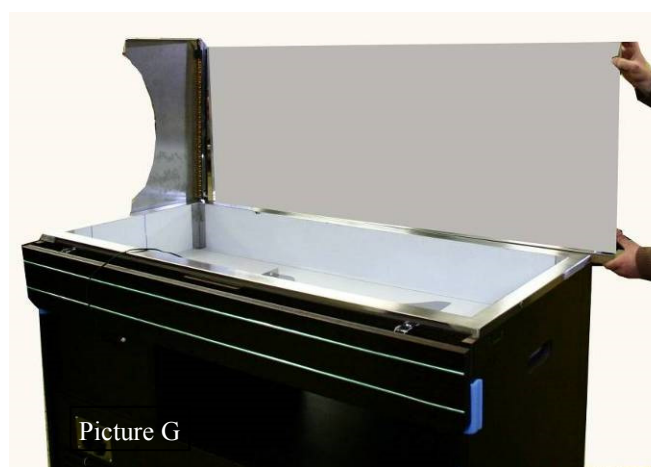

Picture G

### Right upright

A. Remove the protective film from the right upright.



Picture H



## **11. INSTALLATION GUIDE**

### **1. Unpack the salad'bar carefully**

Remove the external protective films and hoopings. Unpack the small parcel placed in the middle of the salad'bar. (This parcel contains the wheels and the screws.)

### **2. Mounting of the castors**

Elements:

- 2 wheels with brake system
- 2 wheels without any brake system
- 16 screws 8x25
- 16 rings

(Picture A)

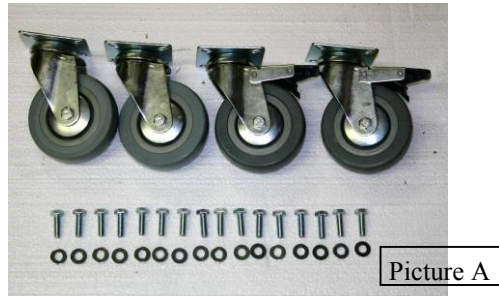

A. Lift up carefully the salad'bar and turn it perpendicular to the pallet. (Photo B)

B. Mount both castors with brake system on the front on the side of the operating panel and both castors without brake system on the back. Fix all parts with a spanner of 13.

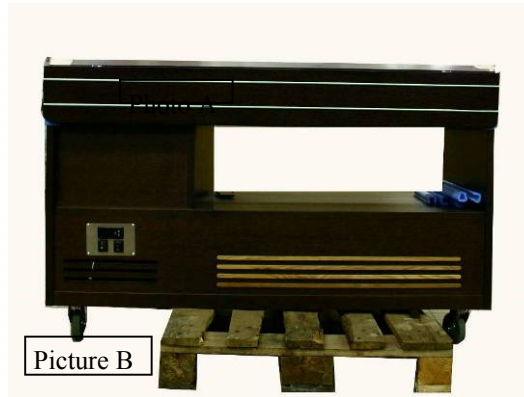

C. Remove the pallet.

D. Remove both brackets at the bottom of the salad'bar.

### **3. Mounting of left / right uprights and of the mirror**

#### **Left upright**

A. Remove the protective film from the left upright. (Picture C)

Picture C



#### **Reach rule**

Never put the device among household waste.

The device must be put down in a centre of recycling for the electric equipments.

The materials of the device are indeed reusable. By eliminating correctly the electric and electronic wastes, the recycling and quite other shape of re-use of worn equipments, you participate in a significant way in the environmental protection.

For any information about the collection of electric and electronic waste, please contact your distributor.

## **10. GUARANTEE**

### **Conditions of guarantee**

The guarantee applicable to any device is the commercial guarantee of the distributor or the retailer. Please contact the store where you bought your device to know the precise conditions.

The guarantee grants no right for damages.

The dispositions which follow are not exclusive of the profit of the legal guarantee planned by articles 1641 and following ones of the Civil code relative to the defects and the latent defects.

### **Exclusion clauses of the guarantee**

**Bad installation and bad maintenance, in particular if they do not respect current regulations or instructions appearing in this user guide.**

Cannot benefit from the guarantee the repairs required as a result of false operations, of inappropriate use, of carelessness or of excess loads of the device, as well as those resulting from variations of the power supply, over tension or from defective installations.

The damage due to shocks, bad weather is not flatware by the guarantee. The material travels at the risks of the user; in case of delivery by carrier, the consignee has to have reservations towards the carrier before any delivery of the device.

The guarantee comes to an end in case of intervention, of repair, of modification by no qualified persons, or of use in inappropriate purposes.