

**INSTRUCTIONS FOUR USE AND INSTALLATION
WALL REFRIGERATED SALAD'BAR
SBM 40 F**



Made in France

WALL REFRIGERATED SALAD'BAR SBM 40 F

Congratulations for the acquisition of this upmarket appliance made in France. You chose an appliance which alloys the best technical qualities with a big user-friendliness. We wish you the biggest contentment

1. SECURITY INSTRUCTIONS

Please respect these instructions scrupulously to avoid any risk of fire, electric shock, scald or other wounds and damage. During the use of this appliance, fundamental circumspection of security must always be noticed, such as:

- Take into account the instructions to be systematically kept with the appliance.
- Install the appliance always in instructions respect.
- Protect the appliance from direct light of the sun, frost and humidity.
- Never leave the appliance within the reach of children or disabled persons without surveillance.
- The machine has to be used only by qualified person.
- Never move the appliance when it is working.
- Check that the appliance is definitely off before connecting it up or disconnecting it.
- Do not use the appliance for other functions than determined use.
- Do not leave the electrical cord in contact of hot surfaces.
- The appliance should not be used close to combustible materials.
- To avoid any electric shock, never plunge the cord or plug in water or quite other liquid.
- If the cord is harmed, it must be replaced by the producer, its after sale service or persons of similar skills to avoid any risk.
- Entrust repairs only to a skilled person.
- Use only spare parts of origin.
- Before cleaning the appliance, do not forget to disconnect it.

2. CONTENTS OF CARDBOARD PACKAGING

Device: a salad'bar

- Accessories:
- Two castors without brake + two castors with brake
 - A mirror
 - A light reflector
 - A left upright and a right upright
 - Two stainless steel protections
 - Screws
 - The present note

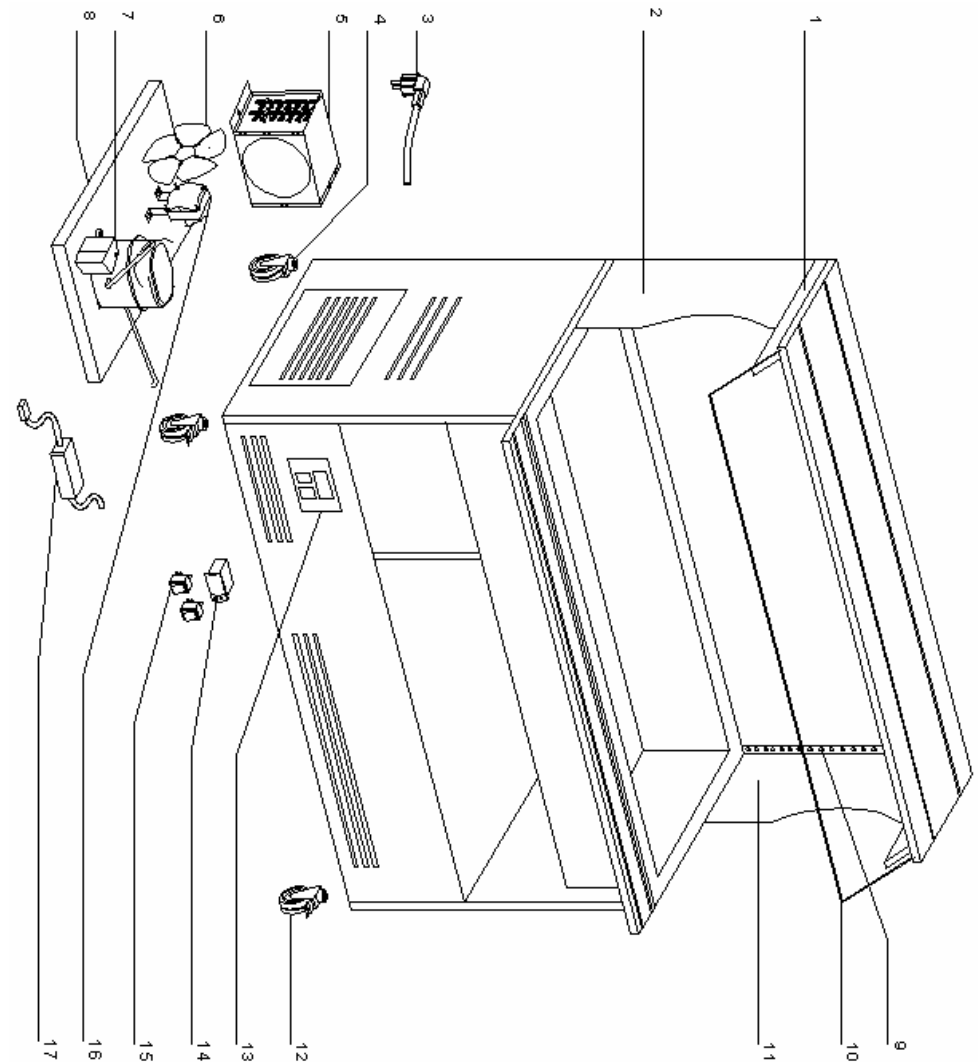

Nomenclature SALAD'BAR MURAL FROID
Spare parts WALL REFRIGERATED SALAD'BAR

Rep	Code	Qty	Pièce	Spare part
1	77047	1	Toit	Roof
2	77050SE	1	Montant gauche	Left upright
3	SC03024	1	Cordon + prise	Cord with plug
4	SF08019	2	Roue sans frein	Wheel without brake
5	SA03047	1	Condenseur	Condensor
6	SA03013	1	Hélice	Fan blade
7	SA03021	1	Compresseur	Compressor
8	77024	1	Support compresseur	Compressor holder
9	SA18035	1	Led	Led
10	SH01103	1	Plexiglas	Plexiglass
11	77051SE	1	Montant droit	Right upright
12	SF08018	2	Roue avec frein	Wheel with brake
13	77022SE	1	Support composant	Control panel holder
14	SA06030	1	Thermostat électronique	Electronic thermostat
15	A07025	2	Interrupteur	Switch
16	SA03012	1	Moteur ventilateur	Fan motor
17	SA03093	1	Alimentation led	Led alimentation

See exploded view at the end of the document

3. CONFORMITY OF USE

Use the salad'bar only to keep your cold meals (cold starters, shellfish, meat, deserts...)at a temperature between +2°C and +10°C during working and service hours. Afterwards they will be stores in a conventional cool chamber.

4. WAY OF FUNCTIONING

These salad'bars exist in 3 versions : SBM 40 F, SBM 40 C, SBM 40 M. They respectively keep the GN containers cold, warm or 2 warm containers / 2 cold containers.

To turn on your salad'bar, press on the left switch (n°3 on picture): the electronic thermostat (n°1 on picture) preset in factory is on. It flashes and then displays the temperature.

Press on the right switch (n°2 on picture) to turn on the light (n°4 on picture).



- 1 Electronic thermostat
- 2 Lighting switch
- 3 On off/ switch
- 4 Light
- 5 Mirror

5. FUNCTIONING / MANIPULATION

a) Installation / assembly:

- Unpack carefully the appliance from its packaging
- Place the equipment on a stable surface.
- Never place the device near a wall or near a partition made of combustible materials.
- Remove the protective film from the appliance.
- Position the accessories (see 11. Installation guide)

b) First starting:

First cleaning

Clean the device before the first use. (See 6 Cleaning)

Connection of the device

- Check that the tension and the frequency of the electricity network suit to the values indicated on the descriptive plate.
- Check that neither the cord nor the plug are damaged
- Make sure that every control knob is positioned on 0.
- Unwind completely the electric power cable and connect it in a normalised plug with the earth.
- The device is connected.

NB: in case of connection of the device in a plug without earth protection or directly on the electricity network, confide its connection to a qualified person .

c) Use of device :

Elements of command and display

Command/Display	Function
Electronic thermostat (n°1 on picture)	Temperature setting
Switch 0/I (n°2 on picture)	Light + turning plates on / Light + turning plates off
Switch 0/I (n°3 on picture)	On/off

6. Connection

Connect every wire. (Picture M)



Photo M

7. Fix the protection for wires

Fix the stainless steel protection for wires with the screws B (Picture F on page 2 + Picture N)



Photo N

8. Final fixation of the mirror

Insert both screws C on the back top of the uprights (Picture F on page 2 + Picture O)

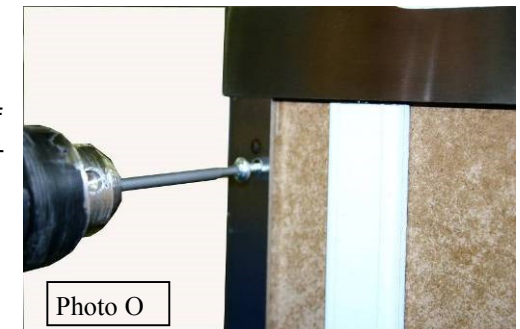

Photo O

Your salad'bar is ready. You can place it and plug in with normalized 220-240 V ~ according to the instructions manual.

Unscrew the protective screw, put the mirror in the slide of the upright and fix again the screw as well as the back screw B (Picture F on page 2).

Attention: Both wires should be outside (Picture I)

At this stage, the mirror is at its place but must be hold.

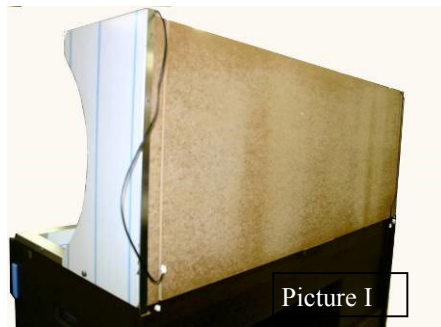

Picture I

5. Mounting of the top parts

A. Mounting of the roof

Remove the protective film from the roof and put the roof on both uprights. (Picture J)



Picture J

B. Mounting of the top shelf

Place the shelf on the roof with both plastic shaped parts up. (Picture K)

Fix the screws A (Picture F on page 2).

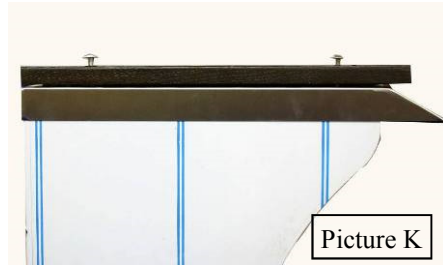

Picture K

C. Mounting of the plexiglas

Remove the protective film.

Place the plexiglas under the stainless steel roof (Picture L) and fix the screws D (Picture F on page 2).

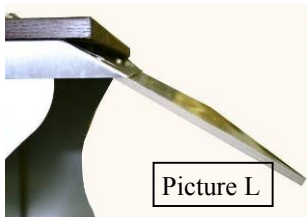

Picture L

Starting

- Press on the switch (n°3 on picture), the machine is on. The preset electronic thermostat flashes and displays the temperature.
- Wait until the salad'bar is at the right temperature
- Press on the second switch (n°2 on picture) to turn on light.

Temperature setting

The electronic thermostat is preset in factory at 2°C. It can be adjusted if necessary.

To modify the temperature, press the "set" key for 5 seconds: the programmed value is displayed and the LED flashes. Use the arrows to adjust your temperature. (between +2°C and +10°C). Press simultaneously on the arrows to validate the new value. The controller returns automatically to the temperature display screen and the LED no longer flashes.

Stopping the appliance

- Set each switch (n°2 and 3 on picture) on 0: the appliance is no longer functioning.
- Disconnect the power cable.
- Clean the appliance. (see 6. Cleaning)

d) Breakdown / repair:

In case of breakdown or of damaged part, please call your after-sales service and confide any technical operation to qualified person.

When you contact the after-sales service of your distributor or your store, give him the complete reference of your device (commercial name, type and serial number). This information appears on the visible descriptive plate behind the device.

6. CLEANING AND MAINTENANCE

Disconnect the device.

- Clean regularly the metallic parts after each use by using only use non-abrasive products, warm water and wash liquid: avoid the abrasive towelling. Rinse your device with a wet sponge and dry it with a soft cloth.
- Never clean the device under a water jet, the infiltrations would risk to damage it in a irreparable way.
- Never immerse the cord or the plug in the water or quite other liquid to avoid any electric shock.
- Never use abrasive product or vinegar; it could damage the container in irremediable way

7. TECHNICAL SPECIFICATIONS

Model	SBM 40 F
Dimensions	1495x855x1405 mm
Weight	100 Kg
Power	500 W
Gas	R 134 A
Temperature	+2° to +10° C
Current	2.5 A
Voltage	220-240 V ~
Colours	Wenge/Light oak / Mahogany

Wires colours correspondence	Phase	Brown / Black / Grey
	Neutral	Blue
	Earth	Yellow-Green

8. NORMS AND LEGALS DISPOSALS

The device is conform to :

- IEC/EN 60335-1
- IEC/EN 60335-2-89
- EN 55014-1 + 55014-2
- EN 61000-3-2 + 61000-3-3

9. ELIMINATION OF THE ELECTRIC AND ELECTRONIC WASTE

The device respects the directives:

2002 / 96 / CE (DEEE) N°34270064800021
 2002 / 95 / CE (ROHS)
 2066/95 CE
 2004/108 CE



Reach rule

Never put the device among household waste.
 The device must be put down in a centre of recycling for the electric equipments.

The materials of the device are indeed reusable. By eliminating correctly the electric and electronic wastes, the recycling and quite other shape of re-use of worn equipments, you participate in a significant way in the environmental protection.

For any information about the collection of electric and electronic waste, please contact your distributor.

B. Unscrew the protective screw on the container (Picture D) and fix the left upright with the screw. (Picture E)

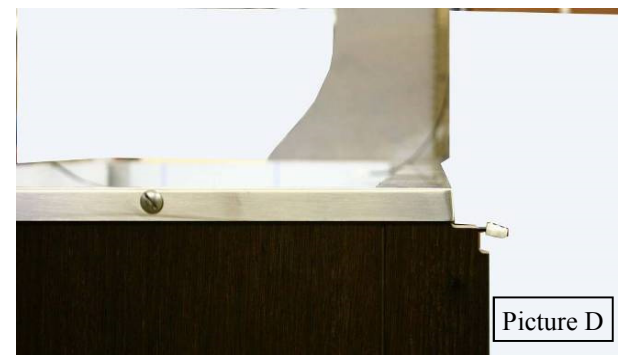

C. Fix the screw B (Picture F) behind the left upright (Picture E).

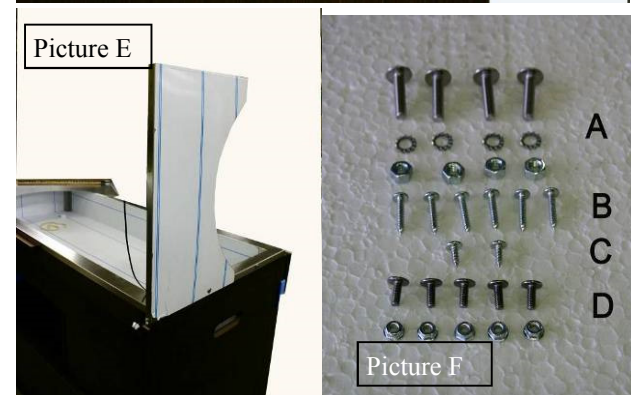

Mounting of mirror

The mirror must be taken by 2 persons and be put along the slide on the left upright. One person must support it in its position. (Picture G)

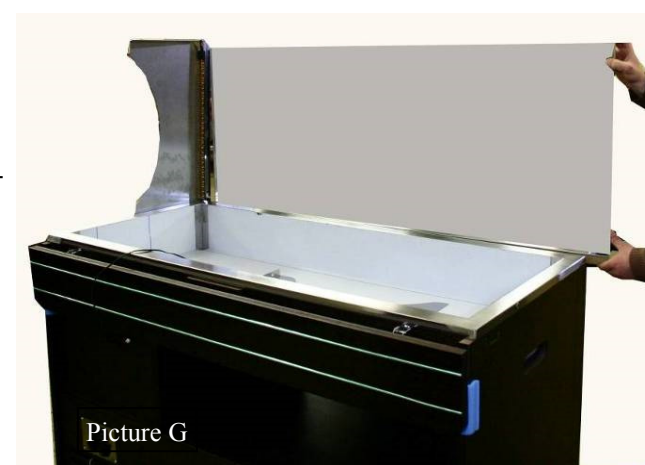

Right upright

A. Remove the protective film from the right upright.

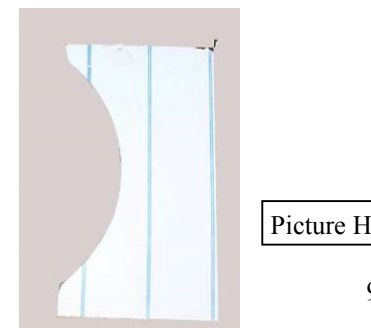

11. INSTALLATION GUIDE

1. Unpack the salad'bar carefully

Remove the external protective films and hoopings. Unpack the small parcel placed in the middle of the salad'bar. (This parcel contains the wheels and the screws.)

2. Mounting of the castors

Elements:

- 2 wheels with brake system
- 2 wheels without any brake system
- 16 screws 8x25
- 16 rings

(Picture A)

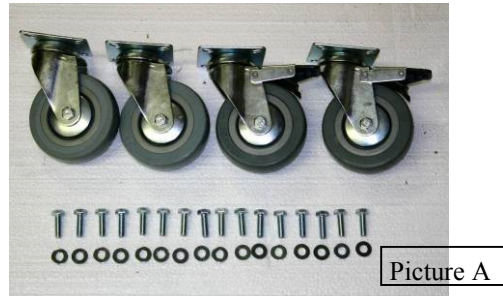

A. Lift up carefully the salad'bar and turn it perpendicular to the pallet. (Photo B)

B. Mount both castors with brake system on the front on the side of the operating panel and both castors without brake system on the back. Fix all parts with a spanner of 13.

C. Remove the pallet.

D. Remove both brackets at the bottom of the salad'bar.

3. Mounting of left / right uprights and of the mirror

Left upright

A. Remove the protective film from the left upright. (Picture C)

Picture C



10. GUARANTEE

Conditions of guarantee

The guarantee applicable to any device is the commercial guarantee of the distributor or the retailer. Please contact the store where you bought your device to know the precise conditions.

The guarantee grants no right for damages.

The dispositions which follow are not exclusive of the profit of the legal guarantee planned by articles 1641 and following ones of the Civil code relative to the defects and the latent defects.

Exclusion clauses of the guarantee

Bad installation and bad maintenance, in particular if they do not respect current regulations or instructions appearing in this user guide.

Cannot benefit from the guarantee the repairs required as a result of false operations, of inappropriate use, of carelessness or of excess loads of the device, as well as those resulting from variations of the power supply, over tension or from defective installations.

The damage due to shocks, bad weather is not flatware by the guarantee. The material travels at the risks of the user; in case of delivery by carrier, the consignee has to have reservations towards the carrier before any delivery of the device.

The guarantee comes to an end in case of intervention, of repair, of modification by no qualified persons, or of use in inappropriate purposes