

BURCO

INSTRUCTION MANUAL

PORTABLE HAND WASH UNIT



Please read and
keep these
instructions

These instructions cover the following Burco models:



444448591



111715

Glen Dimplex UK LTD, trading as,
Glen Dimplex Heating & Ventilation
Web: www.gdhv.co.uk
Millbrook House, Grange Drive, Hedge End, Southampton, SO30 2DF.

UK Customer Service Tel: +44 [0]344 879 3588
ROI Customer Service Tel: +353 [0]1 8424833

www.burco.co.uk



© Glen Dimplex. All rights reserved. Material contained in this publication may not be reproduced in whole or in part, without prior permission in writing of Glen Dimplex

Table of Contents

1.0 About my Product.....	3
2.0 Scope of Delivery	3
3.0 Warnings and Precautions.....	4
4.0 Introduction.....	6
5.0 Warranty Period	6
6.0 Technical Data	7
7.0 Burco Handwash Installation.....	8
7.1 Installation Requirements	8
7.2 European Directives	8
7.3 Before Connection To Power Supply	8
7.4 Location	8
7.5 Electrical Connection.....	9
7.3 Important Safety Instructions	10
7.4 Other Safety Considerations	10
8.0 Operating Instructions.....	11
8.1 Filling	12
8.2 Hand Washing	13
8.3 After Use.....	13
8.4 Protective Cutout	13
9.0 Descaling & Cleaning Advice and Information	14
9.1 Descaling	15
10.0 Troubleshooting	16
11.0 Disposal.....	16
12.0 Spare/Replacement Parts List	17
13.0 Wiring Diagram.....	18
13.1 IR Sensor Version	18
13.2 Foot Pedal Version	19
14.0 Frequently Asked Questions (FAQ's).....	20
15.0 Warranty Information	21
16.0 Terms and Conditions.....	22
17.0 Notes	23

1.0 About my Product

Please take some time to complete the information below; it may save time if you need to contact us for any reason.









Model Number									
Serial Number (this can be found on the data badge on the back of the product)									
Date of purchase									
Purchased from									
In your instruction pack you will find a duplicate data badge, which contains all the critical information above. You can peel of the backing and stick in the box below:									







2.0 Scope of Delivery

The contents of this package include:

- Burco handwash
- Instruction Booklet

3.0 Warnings and Precautions

	WARNING. THIS SYMBOL MEANS THERE IS A RISK OF PERSONAL INJURY.
	IMPORTANT. THIS SYMBOL MEANS THERE IS A RISK OF DAMAGING THE APPLIANCE.
	<p>THIS APPLIANCE MUST BE INSTALLED, COMMISSIONED AND SERVICED BY A QUALIFIED PERSON IN ACCORDANCE WITH THE NATIONAL AND LOCAL REGULATIONS IN FORCE IN THE COUNTRY OF INSTALLATION. ALSO TAKE INTO CONSIDERATION.</p> <ul style="list-style-type: none">• HEALTH AND SAFETY AT WORKS ACT• IEE REGULATIONS• BS CODES OF PRACTICE• LOCAL AND NATIONAL BUILDING REGULATIONS• LOCAL AND NATIONAL WATER REGULATIONS
	<p>THIS APPLIANCE MUST BE INSTALLED;</p> <ul style="list-style-type: none">• IN LOCATIONS OVERSEEN BY TRAINED PERSONNEL• ON A FLAT, HORIZONTAL SURFACE
	DISCONNECT APPLIANCE BEFORE SERVICING, MAINTENANCE OR CLEANING.
	IF THE SUPPLY CORD IS DAMAGED, IT MUST BE REPLACED BY THE MANUFACTURER, ITS SERVICE AGENT OR SIMILARLY QUALIFIED PERSONS IN ORDER TO AVOID A HAZARD.
	DO NOT IMMERSE CORD, PLUG, OR WATER BOILER IN WATER OR ANY OTHER LIQUID.
	THIS APPLIANCE MUST ONLY BE USED FOR HEATING WATER.
	DURING OPERATION PARTS & SURFACES MAY BECOME HOT – AVOID ACCIDENTAL CONTACT.

	THIS APPLIANCE IS NOT SUITABLE FOR OUTDOOR USE OR AN AREA WHERE WATER JET COULD BE USED.
	TO AVOID DAMAGE OF SUFFOCATION PLEASE REMOVE ALL PACKAGING
	DO NOT USE PRODUCT IF THERE IS VISIBLE SIGNS OF DAMAGE
	THIS APPLICANCE IS NOT INTENDED FOR USE BY PERSONS INCLUDING CHILDREN WITH REDUCED PHYSICAL, SENSORY OR MENTAL CAPABILITIES, OR LACK OF EXPERIENCE OR KNOWLEDGE, UNLESS THEY HAVE BEEN GIVEN SUPERVISOR OR INSTRUCTION CONCERNING USE OF THE APPLIANCE BY A PERSON RESPONSIBLE FOR THEIR SAFETY
	CHILDREN SHOULD BE SUPERVISED TO ENSURE THAT THEY DO NOT PLAY WITH THE APPLIANCE
	THE APPLIANCE SHOULD REACH A MAXIMUM TEMPERATURE OF 42°C AND NOT FALL BELOW 42°C FOR OPERATION

4.0 Introduction

Thank you for purchasing this Burco Portable Handwash.

To ensure you obtain the full benefits from your new appliance:

- Please read this instruction book carefully and follow all advice given. Please pay attention to any warnings.
- If you are unsure of any aspects of the information provided, or the setup and performance of the product, please contact our Customer service team on +44 [0]344 879 3588.

The product is intended for commercial use as detailed in these instructions. The Company has a policy of continuous improvement in product quality and design. The company therefore reserves the right to change the specification at any time.

5.0 Warranty Period

This Burco handwash comes with a comprehensive 1-year parts and labour warranty

(Please see page 21 & 22 for full warranty information)

The warranty **does not** cover:

- Consequential damage arising out of any failure acceptable under warranty.
- Accidental damage or misuse as detailed in these instructions.
- Unauthorised alterations made to the appliance that are not made by a Burco-approved engineer.
- Any damage due to incorrect installation, or build-up of scale or food debris.

It is important that you descale your water boiler regularly, particularly in hard water areas.



FAILURE TO DESCALE your water boiler will INVALIDATE YOUR WARRANTY

6.0 Technical Data

Model	HW0110 & HW0110-P
SKU Number	444448591 & 111715
Height (mm)	1010
Tap Height (mm)	170
Width (mm)	390
Depth (mm)	415
Clean Water Capacity (L)	10.0
Number of Handwashes per fill	80
Water Temperature (°C)	42
Water Inlet Pressure (Bar)	1-8
Weight (kg)	9.30
Water Protection	IPX4
Voltage (V)	220-240V~50/60Hz
Power Rating (W)	1680-2000W
Sound Level (db)	<60db



Note this product is IPX4 Rated. This product protects from splashing water in any direction

7.0 Burco Handwash Installation

7.1 Installation Requirements

It is essential that this appliance is installed correctly. Installation should comply with all local electrical, and health and safety requirements.

WEEE directive registration no. WEE/598W

At end of unit life, dispose of appliance and any replacement parts in a safe manner, via a licenced waste handler. Units are designed to be dismantled easily and recycling of all material is encouraged whenever practicable.

7.2 European Directives

As a producer and a supplier of appliances we are committed to the protection of the environment and are in the compliance with the WEEE directive. All our electric products are labelled accordingly with the crossed out wheeled bin symbol. This indicates, for disposal purposes at end of life, that these products must be taken to a recognised collection points, such as local authority sites/local recycling centres

This appliance Complies with European Community Directives (CE) for household and similar electrical appliances and Gas appliances where applicable.

This appliance conforms to European Directive 2009/125/EC regarding Eco design requirements for energy-related products.

7.3 Before Connection To Power Supply

- Remove all packaging.
- Check the appliance for damage. Report any damage immediately to the carrier or supplier.
- Remove any protective plastic coating.
- Any water in the unit is due to testing and is normal.
- Check the available power supply corresponds to that shown on the appliance rating label.

7.4 Location

- This hand wash unit is for indoor use only.
- Only use on a flat level surface.
- Move using the side handles.
- The appliance is only to be installed in locations where its use and maintenance is restricted to trained personnel.

- The mains lead should reach from the mains socket without straining the connections or creating a trip hazard.
- Keep the mains lead away from any hot surfaces.
- Do not place the appliance near a hot gas or electric burner.

7.5 Electrical Connection

- Check that the voltage on the rating plate of your appliance corresponds with your electricity supply which must be A.C. (Alternating Current).
- If the socket outlets are not suitable for the plug supplied with this appliance, the plug should be removed and the appropriate one fitted.
- **WARNING:** This appliance must be earthed.
- The mains lead of this appliance will already be fitted with a BS1363 13A plug. If the fuse must be replaced, use a 13-amp fuse complying with BS 1362.
- A residual current device (RCD) should be used with this unit.
- The RCD must be plugged directly into the socket and the appliance plugged directly into the RCD.



Important: The wires in the mains lead are coloured in accordance with the following code:

Wire Colour	Wire Name	Wire Code
Green & Yellow Wires	Earth	E
Blue Wire	Neutral	N
Brown Wire	Live	L

- The wire which is coloured green and yellow must be connected to the terminal in the plug which is marked with the letter E or the earth symbol or coloured green or green and yellow.
- The wire which is coloured blue must be connected to the terminal which is marked with the letter N or coloured black or blue.
- The wire which is coloured brown must be connected to the terminal which is marked with the letter L or coloured red or brown.

7.3 Important Safety Instructions

- The unit should only be operated on a flat, level surface.
- The unit should only be operated on a dry surface avoiding any possibility of water ingress into the lower electrical compartment.
- **The unit should not be lifted or moved whilst connected to the mains.**
- Always switch off and disconnect the unit from the mains when not in use or when cleaning.
- Children do not understand the dangers associated with operating electrical appliances. Never allow children to use this appliance.

Make sure that the connections are tight and that there are no loose strands of wire and no insulation trapped under the terminals. Tighten the clamp in the plug making sure that it grips the outer covering of the cord. If fitting a BS 1363 13A fused plug, then fit a 13A fuse. Tighten the plug cover securely. If you are in any doubt, consult a qualified electrician.

7.4 Other Safety Considerations

- Do not operate with a damaged lead or plug, or after an appliance has malfunctioned, or has been dropped or damaged in any way.
- Contact Burco for advice on examination, repair, or electrical or mechanical adjustment.
- Do not dismantle any part of the unit. Responsibility cannot be accepted if this instruction is ignored.
- This appliance must only be used for hand washing; it is not intended for dishwashing.
- Maintenance other than cleaning should be performed by the manufacturer while this product is within guarantee (contact our service helpline) or otherwise by a qualified service engineer.
- Unplug from the mains outlet when not in use and before cleaning.



Important: if the supply cord is damaged, it must be replaced by the manufacturer, service agent or similar qualified person in order to avoid a hazard. The supply cord may become warm when the appliance is in use.

WARNING - THIS APPLIANCE MUST BE EARTHED. A RESIDUAL CURRENT DEVICE (RCD) MUST BE USED WITH THIS UNIT (Electrical connection: 220-240V ~50/60Hz, 7.6-8.3A, 1680-2000W)



Important: Please ensure water level does not reach the bottom of the tank before refilling as it may cause a shortage of the electrics.

8.0 Operating Instructions

444448591

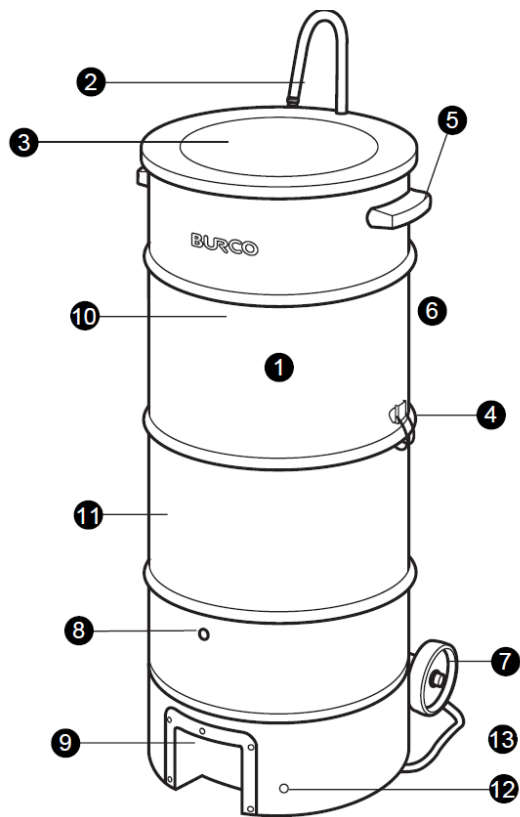

111715



1. Waste Bucket and lid (Inside)
2. Water Spout
3. Sink Bowl
4. Latches connecting top and bottom sections together
5. Handles
6. Water feed tube (Inside)
7. Wheels
8. Overflow
9. Infra-Red Sensor Housing (SKU 444448591 only)
10. Upper Section
11. Lower Section
12. Power Indicator
13. Reset Button (Underneath)

14. Foot pedal (SKU 111715 only)

TURN OFF THE POWER SUPPLY AND REMOVE THE PLUG WHEN NOT IN USE, BEFORE CLEANING, AND BEFORE REPLACING ANY PARTS.

8.1 Filling



Important: Always put water in the unit before switching on.

1. Lift out the bowl by the edges. Raising it off the upper section and sliding it up the water spout. When it is high enough, rotate the bowl and spout until clear of the opening of the upper section.
2. Lift out the waste container, remove the lid and check that it is empty.



Important: This container must be empty before use otherwise there is a chance of over filling.

3. Replace the waste container in the top section and replace the bowl, ensure that it is fitted snugly back in place.

4. To fill, release the catches situated either side of the handwash that secure the upper section to the lower.

5. Lift the upper section until it is clear of the lower section noting two cut outs in the bottom edge. These are to be positioned on the left-hand side of the rolled edge of the lower container giving a resting position and allowing hands free access for filling.

6. Pour clean water into the lower tank. Never fill beyond the MAX fill mark (10 litre) otherwise water will flow out of the overflow.

7. Lift the upper section and replace it on the lower section, aligning the two container seams. Failure to correctly align these sections will result in difficulty in latching the two parts together and may damage the latches themselves.

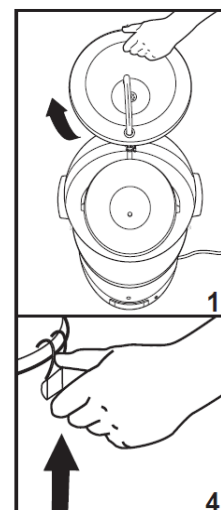

8. Relatch the catches ensuring the wire retainers are situated above the cleat
9. Plug into the supply. The indicator light will illuminate to indicate power to the unit and the water will start to heat up.
10. A) For IR sensor version put your foot momentarily into the black plastic moulding at the bottom of the unit. This interrupts an infra-red beam which in turn operates the water pump. Do this twice to prime the pump. No water will be dispensed until this is done.
 B) For foot pedal version put your foot on the pedal with little force to operate the water pump. The pedal should be pressed for 5-7 seconds per wash
11. The unit takes approximately 15 mins to reach full temperature. The unit is now ready to use.

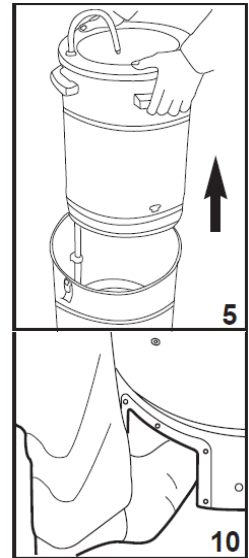

8.2 Hand Washing

1. A) To operate, place your foot momentarily into the black plastic moulding at the bottom of the unit. This interrupts an infra-red beam, which in turn pumps water out of the water spout for approximately 7 seconds. Repeat by momentarily putting your foot back into the plastic moulding once the previous dispense has finished.
 B) For foot pedal version place foot on the foot pedal located at the bottom of the unit. Repeat this process as necessary to dispense water from the water spout. **The pedal should be pressed for 5-7 seconds per wash**
2. When water is no longer dispensed from the nozzle when activated, the lower tank may be empty



Important: Turn off the power and remove the plug when empty.

3. Empty the waste container and refill the lower tank as described above.
4. If there is water remaining in the lower tank check that the quick release fitting is securely attached to both pipes, see cleaning and descaling.

8.3 After Use

Disconnect from the mains supply and empty the waste container.



Water may be left in the lower tank when not in use for short periods, but to maintain a supply of fresh water, it should be emptied periodically and cleaned out.

8.4 Protective Cutout

The hand wash is fitted with a thermal cut-out which protects the unit from damage if allowed to boil dry or switched on without water.

If the cut-out operates, allow the unit to cool down, carefully tilt the unit as there may be water in either the top or bottom sections, then press the red reset button situated underneath the base.

9.0 Descaling & Cleaning Advice and Information

	ALWAYS TURN OFF THE POWER SUPPLY AND REMOVE THE PLUG BEFORE CLEANING, ALLOW THE HAND WASH TO COOL
	THIS HAND WASH IS NOT WATERPROOF
	DO NOT USE A WATER JET SPRAY TO CLEAN THE INTERIOR OR EXTERIOR OF THE APPLIANCE, OR USE A WATER JET IN THE VICINITY OF THE APPLIANCE

To proficiently clean the product, follow these instructions

- Lift out the bowl by the edges raising it the upper section and sliding it up the water spout. When it is high enough, rotate the bowl and spout until clear of the opening of the upper section.

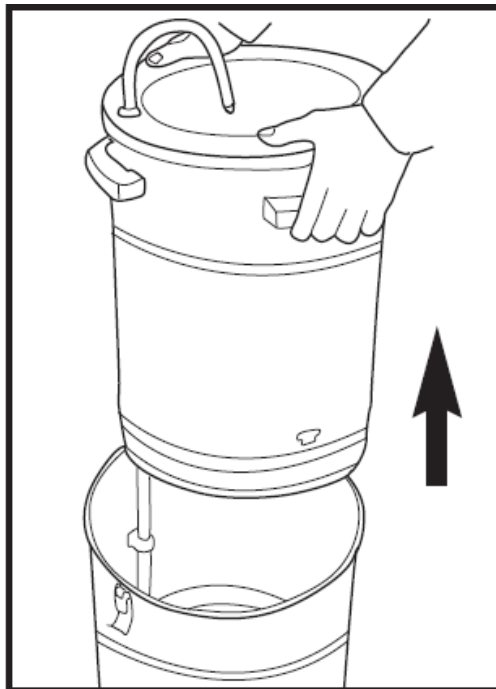

- Locate the quick release fitting, this is the large white plastic fitting joining two pipes.
- Ensure that the bezel is unscrewed to its fullest extent.
- Grip the white fitting and firmly push the plastic ring at the top of the fitting into the body of the fitting.

This will release the lock and allow the upper pipe to be removed. Then push the lower ring into the body of the fitting and remove the fitting from the lower pipe.

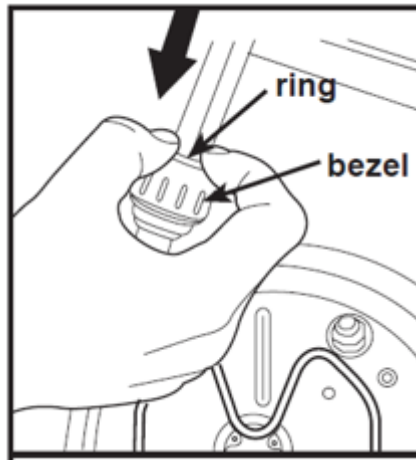

- Release the catches and separate upper and lower sections.

Note: Never clean the unit when it is still hot - wait for it to cool completely to avoid any chance of burns.

Exterior

- Clean with water and detergent. Do not use harsh abrasive cleaners as this could damage the surface finish.

Interior

- Brush any scale or sediment from the element and rinse thoroughly with clean water.

9.1 Descaling

In hard water areas scale will form on the element and interior. This will adversely affect the operation of the hand wash if allowed to accumulate. Descale on a regular basis, using a proprietary descaler recommended for stainless steel kettles. Follow the instructions provided with the descaling product, and then refill with fresh water, heat and discard the water before general use. **This must be done three times.** Do not use the descaler unless the manufacturer specifically states it is suitable for water boiling applications.



IMPORTANT: Failure to descale will invalidate your guarantee.

10.0 Troubleshooting

Fault	Possible Cause	Remedy
The appliance does not operate	No power to the appliance	Check supply socket is switched on
		Check fuse and circuit breaker
		Check green power indicator is illuminated
	Product is Empty	Refill product
	Thermostat or element faulty	Replace thermostat or element

11.0 Disposal

At the end of the appliance's useful life, it should not be disposed of with household waste. Please recycle where facilities exist. Check with your local authority for recycling facilities and advice in your area



For electrical products sold within the European Community. At the end of the electrical products useful life it should not be disposed of with household waste. Please recycle where facilities exist. Check with a Local Authority or retailer for recycling advice in your country. Batteries should be disposed of or recycled in accordance with WEEE Directive 2012/19/EU. Packaging should be

12.0 Spare/Replacement Parts List

Genuine replacement Burco parts must be fitted. If generic non-Burco parts are fitted, you may prevent your appliance from operating safely and in the most efficient manner and invalidate your warranty

Description	IR Sensor Version (SKU 444448591)	Foot Pedal Version (SKU 111715)
Element kit Inc. seal BBU59151	SP082610801	SP082610801
Green Neon Assy	SP62448	SP62448
Wheel assembly	SP62619	SP62619
White plastic lid	SP082626782	SP082626782
Bucket 10L White	SP62635	SP62635
Funnel	SP62636	SP62636
Tap pipe assembly	SP083155800	SP083155800
Hand wash bowl assembly	SP083327100	SP083327100
IR housing unit assembly	SP62672	SP01/110584/0
Pump assembly	SP62625	SP62625
Handle assembly	SP60109	SP60109
Thermostat 55.13102.150	SP62629	SP62629
Reset rod tube & Spring Set	SP59093	SP59093
Overheat thermostat	SP62819	SP62819
Spiderfixes push-on	SP62658	SP62658
Footpedal	N/A	SP03/24017/0
Cable Gland	N/A	SP03/24018/0

For further information or to purchase spare parts, please contact our Aftersales team on +44 [0]344 879 3588. Please ensure you have the details of the model and serial numbers to hand. These can be found in the "About my product" section on page 2. These can also be found on the data label at on the back of the appliance.

13.0 Wiring Diagram

13.1 IR Sensor Version

The wiring diagram for the Burco Handwash Product Number 444448591 is shown below. Wiring should be replaced by the manufacturer, service agent or similar qualified person in order to avoid a hazard.

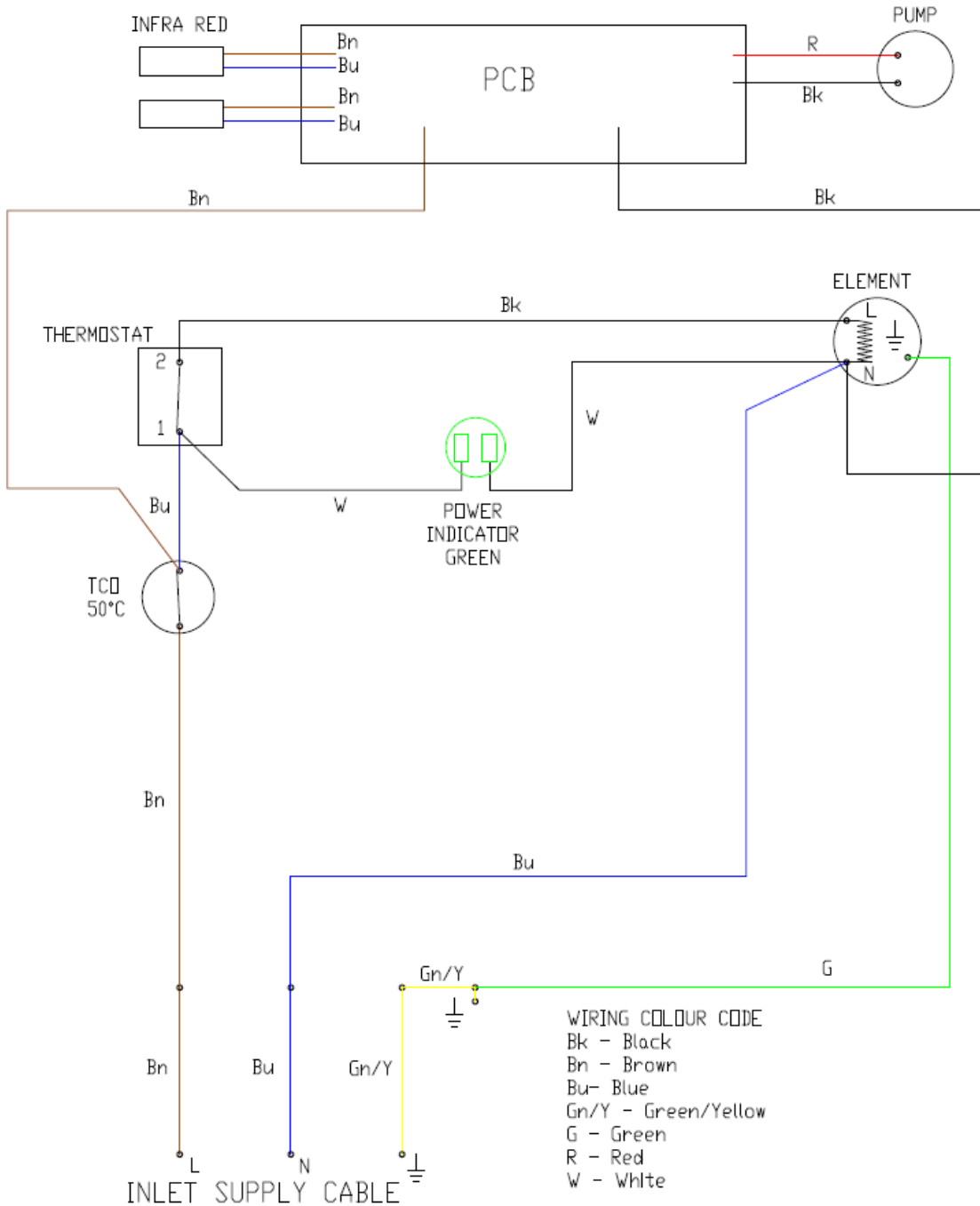

This diagram is the property of Glen Dimplex UK Ltd. and is not to be reproduced or transmitted in any shape or form without the permission of Glen Dimplex UK Ltd.

13.2 Foot Pedal Version

The wiring diagram for the Burco Handwash Product Number 111715 is shown below. Wiring should be replaced by the manufacturer, service agent or similar qualified person in order to avoid a hazard.

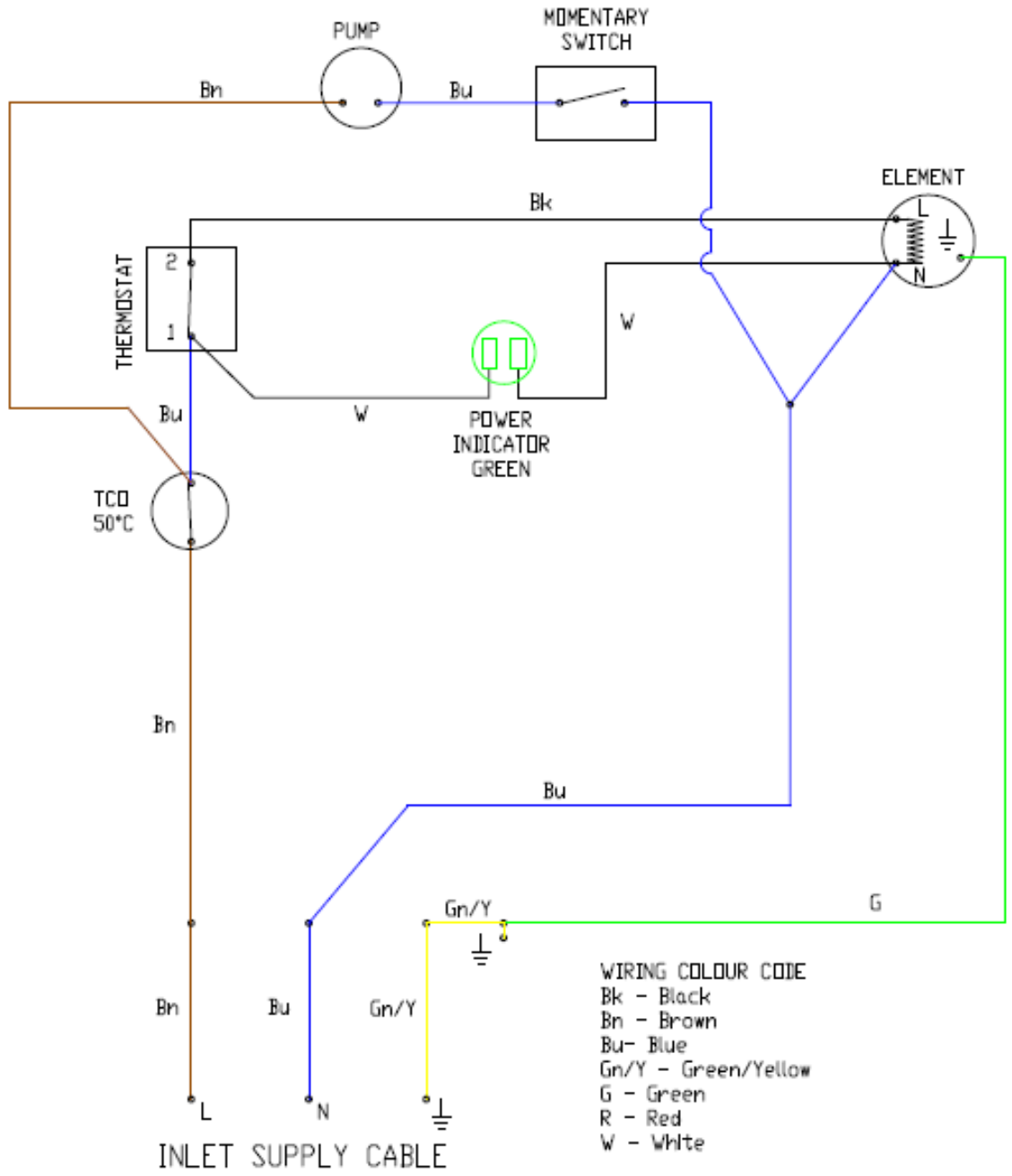

This diagram is the property of Glen Dimplex UK Ltd. and is not to be reproduced or transmitted in any shape or form without the permission of Glen Dimplex UK Ltd.

14.0 Frequently Asked Questions (FAQ's)

The following list of FAQ's may help you with any information or problems with your Burco handwash.

Alternatively, please contact our Aftersales Team on +44 [0]344 879 3588 if your question is not covered below or if you aren't sure about something.

Q. Are there any restrictions as to where I should locate my Burco handwash?

A. Yes, your appliance should be positioned on a flat, horizontal surface that can take the weight of the appliance when full of water. Consideration must also be given to servicing requirements and safe operational access to the appliance must also be ensured. For a detailed overview of installation requirements, please refer to Page 8 of this instruction book.

Q. There is no water coming from the tap?

A. Check that the water tank is full, and the appliance is switched on.

Q. The water from the tap is cold?

A. Check the appliance is connected to mains power and restart product. If you require further help, please contact our Aftersales Team on +44 [0]344 879 3588.

Q. What Warranty does my water boiler have?

A. Your Burco handwash will come with a 1-year parts and labour warranty. Please see the 'Warranty' section on page 6 for details.

Q. Can I purchase any replacement parts?

A. Yes, we have several replacement parts available. If you require any spare parts, please do not hesitate to contact our Aftersales Team on +44 [0]344 879 3588 and they will be happy to assist.

15.0 Warranty Information

What does a Burco Warranty cover?

Burco products deliver reliable service for normal use in commercial settings. All Burco products are individually tested before leaving the factory.

If you are a consumer and you experience a problem with your Burco product, which is found to be defective due to faulty materials or workmanship within the Warranty Period, this Burco Warranty will cover repair or - at the discretion of Burco – replacement with a functionally equivalent Burco product. The Burco Warranty Period is one calendar year from the date of purchase of your Burco product, or the date of delivery of the product, if later. The Burco Warranty is conditional upon you providing the original purchase receipt as proof of purchase. Please therefore retain your receipt as proof of purchase.

If you do experience a problem with your Burco product, please call the Helpline on +44 [0]344 879 3588 or visit <https://www.dimplex.co.uk/support>.

For ROI please email serviceireland@glendimplex.com or call +353(0)1 842 833. We will need details of your Burco product, its serial number and a description of the fault which has occurred. You can find the model number and serial number for your Burco product on the lower half of the product. Once we receive your information and proof of purchase, we will contact you to make the necessary arrangements. If your Burco product is not covered by this Burco Warranty, there may be a charge to repair your product. However, we will contact you for agreement to any charges before any chargeable service is carried out.

What is not covered by a Burco Warranty?

The Burco Warranty does not cover any of the following:

- Any fault or damage to your Burco product due to faulty materials or workmanship occurring outside the one-year Warranty Period.
- Any fault or damage occurring to any pre-owned Burco product or to any other equipment or property.
- Accidental damage to your Burco product or damage to your Burco product from external sources (for example, transit, weather, electrical outages or power surges).
- Fault or damage to your Burco product which is:
- Not due to faulty materials or workmanship or which is due to circumstances outside Burco's control.
- Caused by use of your Burco product for anything other than normal commercial purposes in the country where it was purchased.

- Caused by any misuse, abuse or negligent use of the Burco product, including but not limited to any failure to use it in accordance with the Operating Instructions supplied with the product.
- Caused by any failure to assemble, install clean and maintain your Burco product in accordance with the Operating Instructions supplied with the product unless this was carried out by Burco or its authorised dealers.
- Caused by repairs or alterations to your Burco product not carried out by Burco service personnel or its authorised dealer(s).
- Caused by use of any consumables or spare parts for your Burco product which are not Burco -specified

16.0 Terms and Conditions

The Burco Warranty is valid for Burco from the date of purchase of your Burco product from a recognised retailer in the country of purchase and use, or the date of delivery of the product if later, always provided the original receipt has been retained and is produced as proof of purchase.

You must provide to Burco or its authorised agents on request the original receipt as proof of purchase and - if required by Burco - proof of delivery. If you are unable to provide this documentation, you will be required to pay for any repair work required.

Any repair work under the Burco Warranty will be carried out by Burco or its authorised dealer(s) and any parts that are replaced will become the property of Burco. Any repairs performed under the Burco Warranty will not extend the Warranty Period.

Any replacement of your Burco product by Burco during the Warranty Period will start the one-year Warranty Period afresh from the date of delivery of the replacement Burco product to you.

The Burco Warranty does not entitle you to recovery of any indirect or consequential loss or damage including but not limited to loss or damage to any other property.

The Burco Warranty is in addition to your statutory rights as a consumer and your statutory rights are not affected by this Burco Warranty.

Contact Burco

If you have any questions about what the Burco Warranty covers and does not cover or how to claim under the Burco Warranty, please contact us using the information on the back page. To view the Product Guarantee T & C visit <https://www.gdhv.co.uk/guarantee-terms-and-conditions>

17.0 Notes

Disregarding the instructions given in this manual in its entirety and any relevant regulations, standards and code of practice will void the guarantee of this product. Glen Dimplex reserve the right to revise products, literature and guarantee terms without prior notice due to a policy of continuous improvement

To speak to customer services please contact:

Glen Dimplex UK LTD.

Millbrook House, Grange Drive, Hedge End,
Southampton, Hants, SO30 2DF, United Kingdom

Register in England and Wales with Company No.1313016

UK Telephone Number - Customer Support: +44 [0]344 879 3588

ROI Telephone Number – Customer Support: +353 (0)1 8424833

Fax: 0844 879 3583

Email: customer.services@glendimplex.com

